

COMPENDIUM

66





VISIT US AT: WWW.PLATIT.COM



You can view our units in 3D by scanning the pages marked with this symbol with our AR app.

Table of contents

About us	4
Know-how	11
Standard coating units	23
• PLATIT 11-Series overview	24
• 111 Smart Speed Unit	27
• 411 Ultra Flexible Unit	33
• 1011 High Volume Unit	39
• 11-Series accessories	43
Coatings	49
• Cathode configurations	50
• Coatings for cutting tools	52
• Coatings for chipless forming	54
• Coatings for components	55
• Coating properties	56
• Signature and Dedicated Coatings	57
Custom Coating Solutions (CCS)	69
• CCS for DLC	72
• CCS for XL Rotating Cathodes	74
• CCS for Saw Bands	76
• CCS for Saw Blades	78
• CCS for Rollers	80
• CCS for Coin Minting Dies	82
Turnkey Solutions	85
• The TKS concept	86
• Decoating	88
• Edge pre-treatment	93
• Cleaning	98
• Quality control	100
• Post-treatment	101
PLATIT's Lifecycle Management	103
Sales network	108

COMPENDIUM



Global presence

PLATIT is a leading manufacturer of high-tech PVD and PECVD coating units for tools and components. The company is part of the family-owned BCI Blösch Group, an independent Swiss technology group. PLATIT is headquartered in Selzach (Switzerland) and has its own service, support and sales offices in Europe, North America and Asia. These are complemented by a broad network of distributors and partners worldwide. PLATIT has installed coating systems worldwide and maintains close partnerships with its customers.

The variety of tool geometries and applications requires manufacturers of coating equipment to offer a wide range of technical solutions to best fulfill customers' needs. PLATIT offers numerous high-tech standard and custom coating solutions with modular machine designs, high flexibility and proven

user-friendliness. Profound competencies in cathodic ARC, SPUTTER and HiPIMS technology allow PLATIT to integrate these technologies into hybrid processes, creating solutions for different applications. PLATIT's open-source philosophy helps customers to adapt coatings to their specific requirements and individual needs. With the highest coating performance in dedicated application fields, PLATIT customers can differentiate themselves from the market standard.

In addition to coating units, PLATIT offers turnkey systems as part of its product portfolio. These include complete solutions for upstream and downstream steps such as decoating, edge pre-treatment, cleaning, post-treatment and quality control, making PLATIT systems ideally suited for seamless integration into the tool manufacturing and regrinding process.

PLATIT has installed coating systems for customers in 43 countries around the world:

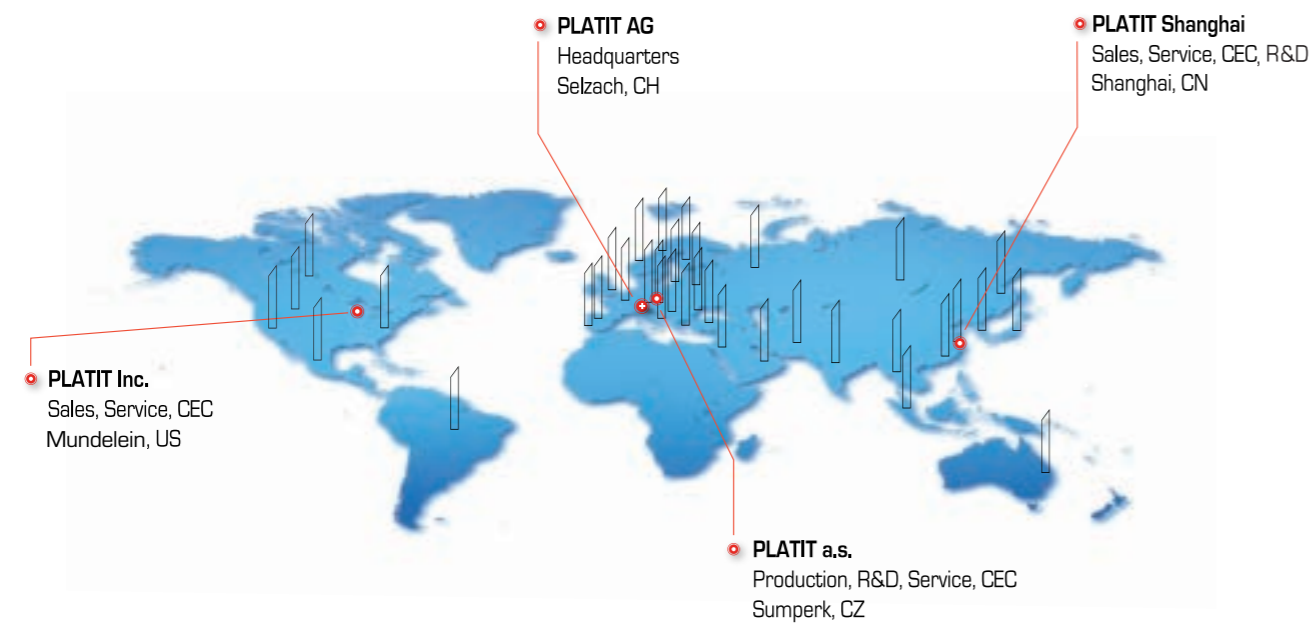

What we stand for

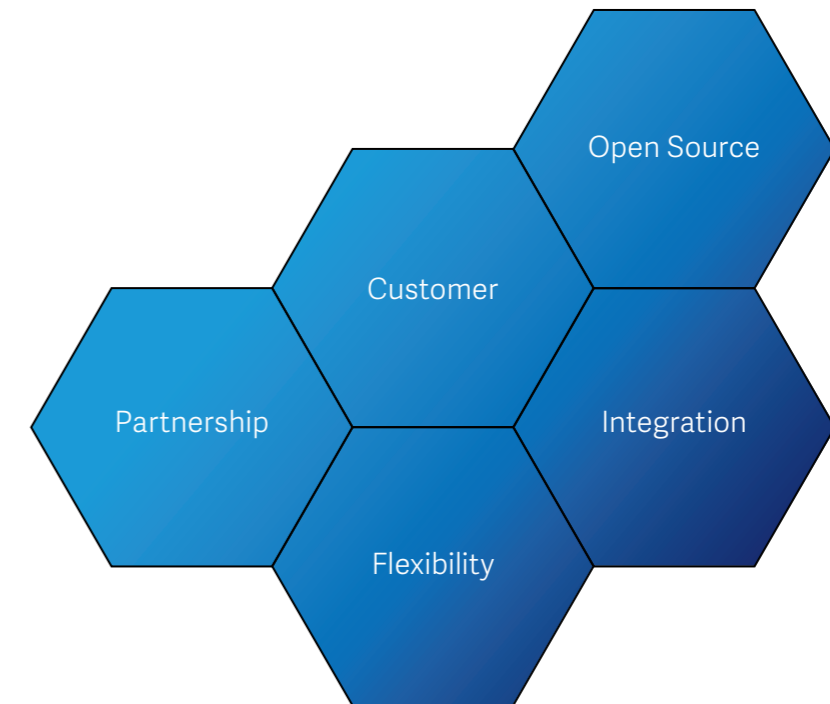

Core competencies of PLATIT include integrated turnkey solutions, flexible machine concepts, open-source technology and strong customer relationships.

Integration enables in-house coating. Based on our comprehensive understanding of the manufacturing and regrinding of tools, we develop optimized solutions for our customers, which we seamlessly integrate into their existing production process.

Flexibility refers to our business model and our products. Our PVD standard coating units are based on a modular design. With different implemented technologies, they can produce a variety of coatings and deposit complex layers. The coating units are ideally suited for the development of customized coatings and ensure that our customers can set themselves apart from their competitors by creating their own brand image. Furthermore, the Custom Coating Solutions division integrated into our dual business model gives us the flexibility to build customized PVD systems dedicated exclusively to a single customer, use or purpose.

Open-Source technologies inspire innovations. By purchasing our technology, customers can participate in our know-how. Our systems are open to engineers, their parameters and recipes can be changed and further developed if needed. We also value interactions, discussions and sharing knowledge with technology users, as we firmly believe that both parties benefit from transparency and openness.

We believe in **strong customer relationships**, ensuring our customers are always satisfied. We stand by our customers with worldwide service, support and sales offices as well as with our partners for upstream and downstream processes. Our customers benefit from our network, which matches supply with demand for tool manufacturers, regrinders and coating centers. As a premium provider, we can assist our customers in customer acquisition: we provide support from sampling to the adaptation of coatings resulting in innovations. PLATIT does not offer job coating services and therefore avoids entering into competition with its customers.

Milestones

Walter Blösch establishes W. Blösch AG as a company providing gold plating for watch cases and jewelry and manages the company until 1994

Company

1947

R&D

PLATIT AG is founded

1993

First PLATIT PVD hard coating unit: PL1000

Peter and Erich Blösch take over the company as second-generation owners

1994

Founding of PLATIT Inc. in the US

1999

2000

Market launch of PLATIT Turnkey Solutions

Founding of PIVOT in a joint venture with SHM in the Czech Republic

2001

Formation of PLATIT a.s. in the Czech Republic by fully integrating PIVOT a.s. into PLATIT Group

2013

Market launch of the Pi411 with SCIL®

Founding of PLATIT Advanced Coating Systems (Shanghai) Co., Ltd., in China

2011

Introduction of LGD® etching technology

2010

Market launch of the PLATIT 11-Series with the Pi111

2009

Release of DLC2 (PECVD) processes (a-C:H:Si)

2005

First coating unit with LARC® and CERC®: Pi300

2003

- First coating unit with rotating LARC® and nano-composite coatings: Pi80
- PL2001: Custom Coating Solution for saw blades

Integration of the custom-coating-systems engineering company PLANAR SA into PLATIT AG

2017

Release of the new generation of the Pi411 with additional hybrid LACS® technology with simultaneous ARC and SPUTTER processes

Management transition to the third generation of the family-owned company with Patrick, Pascale and Dominik Blösch

2018

2019

- Market launch of the PL711
- S-MPuls: Custom Coating Solution for coin minting

2014

Market launch of the ultra-fast CT40 decoating system

2015

- Market launch of the Pi1511
- Introduction of the new PLATIT SmartSoftware

2016

Release of the new generation of the PL1011 High Volume Unit

2025

- Release of Pi411 G3
- Release of PL1011 SAT
- Release of Omnis-BX
- Release of Ti-BX
- Release of TiAlloy-X
- Release of Corro-X

2024

Release of Pi111 TRM

2023

- Release of the TapCT coating
- Release of the FeinAI Plus
- Release of the Ceramicoin coating for coin minting dies

2022

- Release of 3D etch indicator
- Release of the Omnis coating

2021

Release of the new generation of the PL1011 and Double-Pulsed features

2020

- Release of ta-C coatings in Pi411
- PL2011: Custom Coating Solution for saw blades
- Mega-PiMS: Custom Coating Solution for rollers and broaches
- Release of the new generation of the Pi111 Smart Speed Unit

Benefits of PLATIT solutions

The turnkey solutions from PLATIT are ideally suited for a seamless integration into the tool manufacturing and regrinding process.

For coating centers, PLATIT provides solutions that meet the various challenges of their customers.

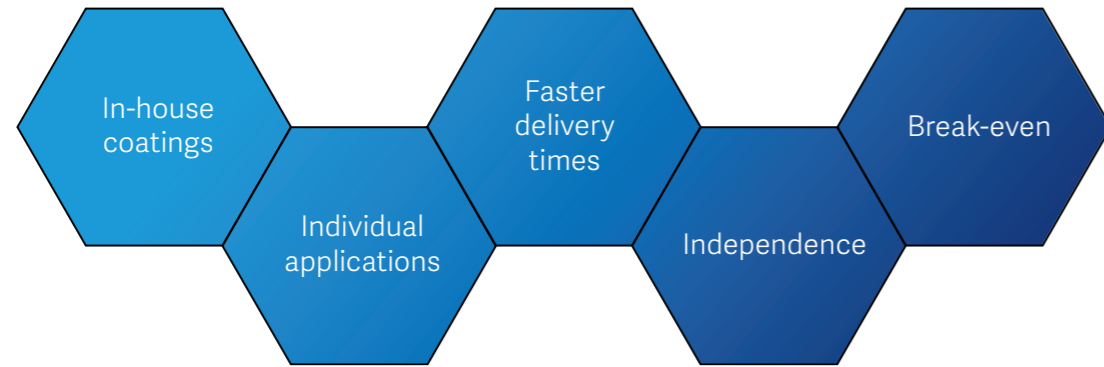

In-house PLATIT units for tool manufacturers and regrinders

The integration of coating units into the in-house tool manufacturing or regrinding process offers a variety of advantages:

- **Independence:** with your own turnkey system, the entire production is in your own hands. There are no dependencies or risks on the supply chain.
- **Faster delivery times:** in-house processes allow production, grinding and coating to take place on the same day, ensuring the shortest possible routes and preventing transport damage.
- **Coating know-how for individual applications:** a coating center mixes different tools; processes are designed for general use, not specifically for individual applications. In-house, coating thickness and quality can be adapted and controlled.
- **Dedicated Coatings:** PLATIT's open-source technology, which makes it possible for customers to develop their own coatings, guarantees the potential for differentiation from the competition.

Especially tool manufacturers with a high demand for the latest technologies and innovative PVD coatings benefit from the properties of PLATIT's Pi technology in terms of a unique competitive advantage.

As a manufacturer or regrinder you are focused on producing the best tools or components for your

markets, where competition is continuously getting stronger. You have already considered investing in a high-tech PVD coating system to get your tailored high-performance PVD coatings, but besides the tough choice of picking the right technology, you ask yourself how coating your tools and components in-house pays off in comparison to continuing to use job coating services.

To assist you with this comparison, we provide you the table and graph with examples of an US SME producing 3/8" x 3" shank tools and using two coatings – Omnis and nACo. We show a monthly cost comparison between using job coating services and an in-house PLATIT PVD coating system.

External job coating costs are based on market prices in US and complemented by costs for internal resources needed for order processing and logistics. For the in-house PLATIT coating system, the investments are calculated including the required peripheral devices such as a chiller, a cleaning system and quality control (USD 800,000), financed by leasing (5 years, 20% down payment, 20% residual value, 5% interest rate); salaries, rent, maintenance, energy and consumables (incl. gas, targets, water, and cleaning solution).

Cashflow USD / month	Pi111 G3				
	Year 1 / per month 2,175 tools / month	Year 2 / per month 4,680 tools / month	Year 5 / per month 10,560 tools / month	Year 6 / per month 10,560 tools / month	Accumulated Total Cashflow for Year 1–6
Job coating spendings	10,603	21,294	41,184	41,184	2,152,305
Internal logistics wages	720	1,440	2,880	2,880	146,880
Total job coating cashflow	11,323	22,734	44,064	44,064	2,299,185
Leasing	9,646	9,646	9,646	fully paid	578,760
Space rent	309	309	309	309	22,273
Salaries	1,440	2,880	5,760	5,760	293,760
Maintenance & wear parts	115	690	1,380	1,725	71,760
Cathode exchange	240	2,141	4,281	4,281	208,376
Other var. costs	146	292	585	585	29,820
Total in-house cashflow	11,897	15,985	21,961	12,660	1,204,750
Down-/final payment					- 320,000
Delta job coating vs. in-house coating	- 573	+ 6,776	+ 22,103	+ 31,404	+ 848,750

This cost comparison reinforces the following statements:

- If you are spending around USD 125,000 annually on job coating, an investment in an in-house PVD system should be your next step
- Investing in PVD technology already generates a positive cash flow shortly after the investment
- After about 2.5 years, the accumulated positive cashflow surpasses the initial investment
- Cash is invested in the company's assets by growing its machine park and is not lost in spending for external job coating service
- Over a six years period, there is the potential to generate a cash surplus of > USD 800,000 in addition to growing the company's assets

Cumulative cashflow in USD: Job coating vs. in-house coating

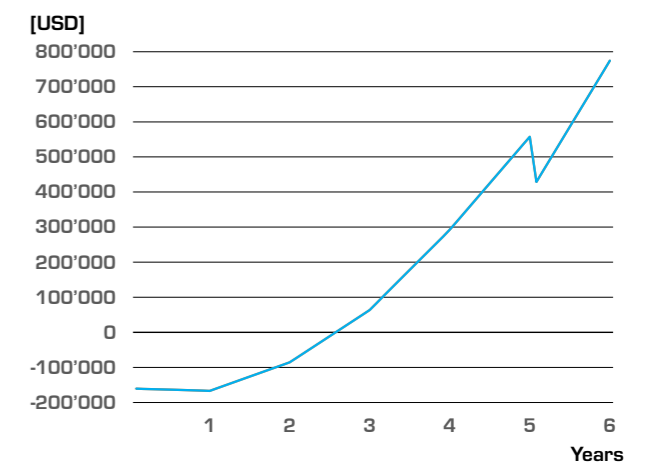

Detailed case description:
US SME: tool manufacturer, 3/8" x 3" shank tools, Omnis & nACo, max. 208 tools / batch (kicker-system). Year 1 = 15 batch / month; year 5 = 60 batch / month
Costs included: Investment costs for turnkey system including chiller, cleaning system and quality control (USD 800,000), financed by leasing (5 years, 20% down payment, 20% residual value, 5% interest rate); salaries, rent, maintenance, energy and consumables (incl. gas, targets, water, and cleaning solution)

Benefits of PLATIT solutions

PLATIT units for coating centers

Coating centers have different demands regarding a PVD coating system than tool manufacturers or regrinders. Example requirements are listed below:

- **Flexibility:** PLATIT standard and custom coating solutions can be programmed with different coating technologies. The systems can deposit various nitride, oxide and DLC coatings using PVD and PECVD without needing to change the targets. True to the open-source approach, they are suited for the development of Dedicated Coatings.
- **High-quality coatings:** in depositing coatings, PLATIT units combine high performance with very short cycle times.
- **Partnerships:** PLATIT attaches great importance to strategic partnerships, as both parties benefit from sharing knowledge, and therefore supports coating centers from sampling to the adaptation of coatings. With worldwide service, support and sales offices as well as a network for upstream and downstream processes, PLATIT always stands by its customers.
- **Customer acquisition:** as a premium supplier, PLATIT can assist coating centers in customer acquisition and bring together supply and demand.
- **No competition:** to PLATIT, it is very important that there is no competition with its own customers. For this reason, it has and will not set up any coating centers in its target markets.

Strengths of PL1011 SAT

Our high-volume coating unit PL1011 is especially suited for coating centers. The PL1011 enables coating centers to meet the high-quality demands of their customers. The planar targets, which are considered standard on the market, guarantee a cost-efficient coating.

PL1011 SAT:

- Revolutionary Supreme Arc Technology
- Four Planar ARC cathodes with double-pulsed technology
- Low costs per tool
- For coating large quantities of different tools
- Suitable for a wide range of application
- Dense, high quality coatings
- Outstanding surface quality

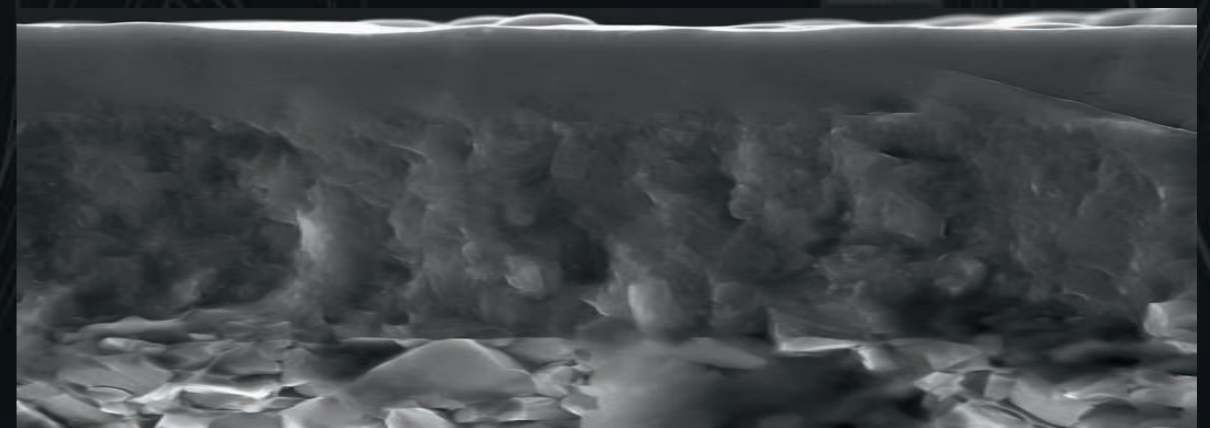

KNOW-HOW

PLATIT® 11-Series

PVD hard coating

A coating is a thin protective film intended to improve the surface properties of a base material in terms of:

- Hardness
- Oxidation resistance
- Friction
- Fracture toughness
- Chemical stability
- and many other properties depending on the applications

With just a few microns, the coating on a cutting tool allows for example for faster cutting speeds, resulting in higher productivity and a longer lifespan of the base material.

Comparison between a human hair and hard coating:

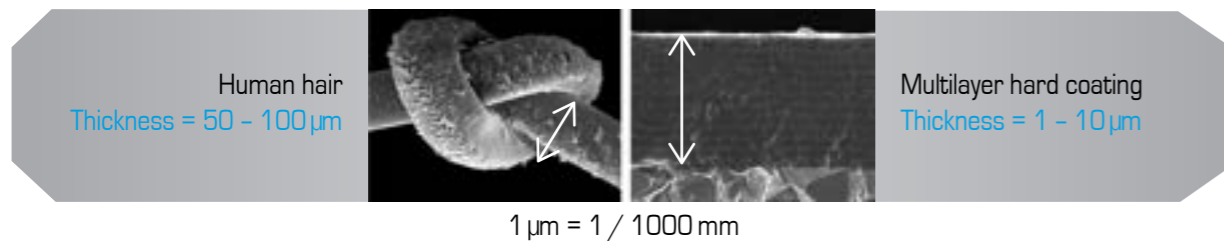

Comparison of hardness from the softest to the hardest material:

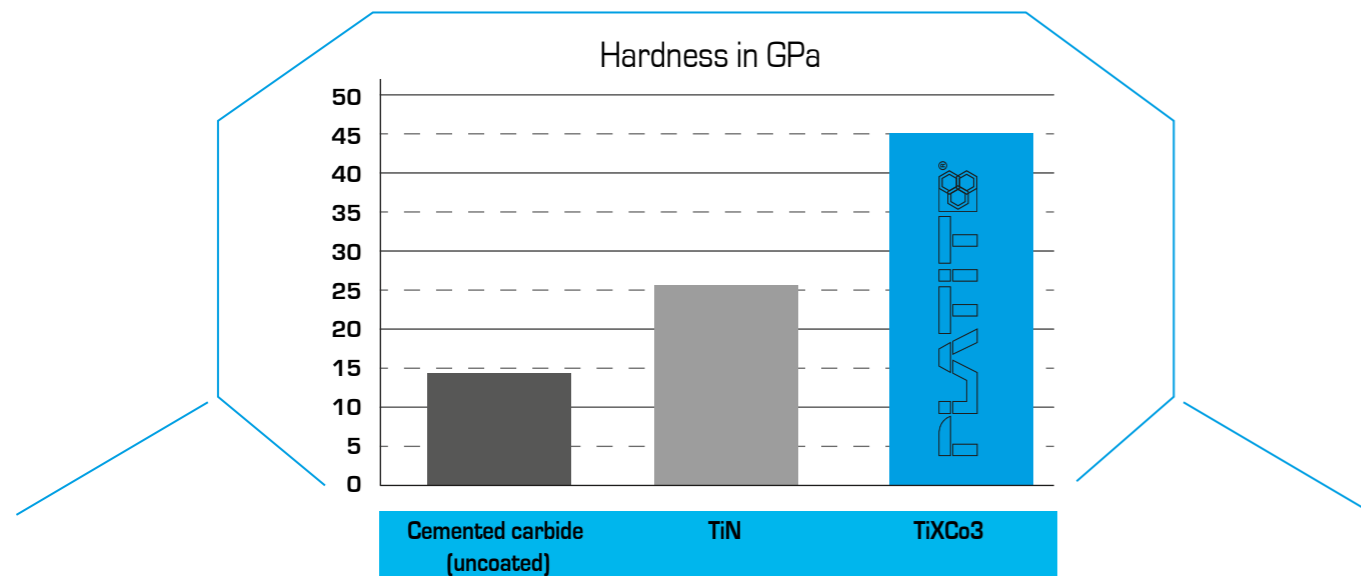

Coating process

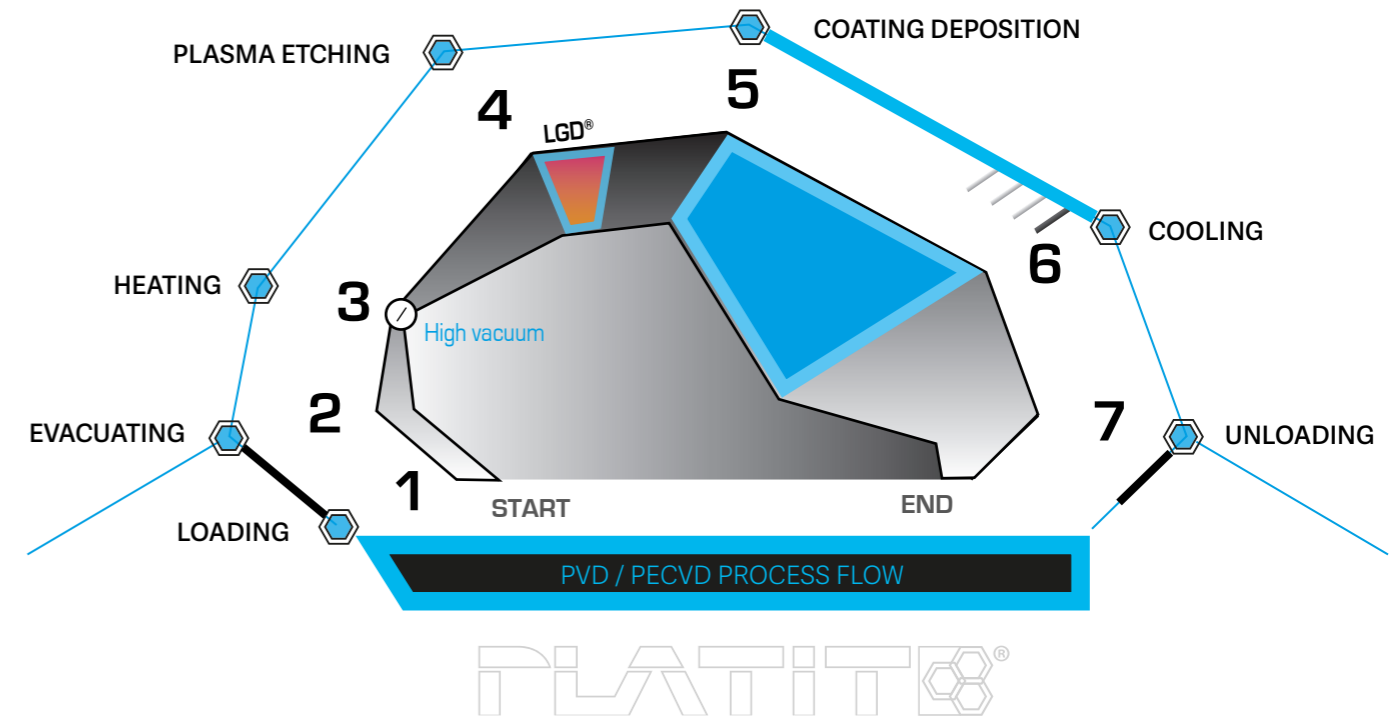

- 1. Loading**
The coating chamber is loaded
- 2. Evacuating**
A high vacuum is required for depositing PVD coatings. The evacuation in PLATIT coating units takes place in two steps:
 - 2.1 The rotary-vane pump generates an inlet pressure in the chamber from atmospheric pressure down to 10^{-2} mbar
 - 2.2 The turbomolecular pump generates a high vacuum of approximately 1×10^{-5} mbar
- 3. Heating**
The chamber is heated up. Process temperatures are about $150-500^\circ\text{C}$
- 4. Plasma etching**
PLATIT coating units work with three different etching processes:
 - LGD (Lateral Glow Discharge)
 - Plasma etching with argon, glow discharge
 - Metal ion etching (Ti, Cr)
- 5. Coating deposition**
Coating deposition with PVD (ARC, SPUTTER or hybrid LACS technology) or PECVD processes
- 6. Cooling**
Cooling of the coating chamber
- 7. Unloading**
The coating chamber is unloaded

Coating process

LGD® etching

LGD (Lateral Glow Discharge) is the patented etching process in PLATIT's coating units. It takes place before the coating process. Thanks to plasma with high ion density generated by an electron flow between two cathodes, LGD® can process even complex surfaces and cavities as well as cutting-edges (e.g. of hobs, molds and dies).

Plasma etching:

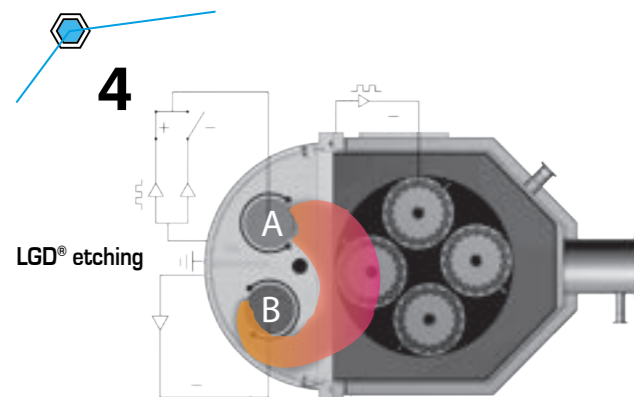

Highlights:

- Low antenna effect due to low bias voltage
- Increased mean free path
- Better etching penetration → improved etching of flutes

Use of shutters:

- Targets are cleaned by igniting an ARC behind the shutter on the target surface without contaminating the tools
- The shutter is opened after the cleaning process of the target, which creates ideal conditions for optimal coating adhesion

Comparison of different etching methods:



Tool: milling head; insert ADMX 11T308SR; z = 4
Cooling with emulsion; ap = 8 mm; ae = 22 mm; vc = 80 m/min;
f = 0.1 mm/rot
TiAlN 1x with LGD® and 1 x plasma etching with argon

Increased tool life by LGD® at hobbing

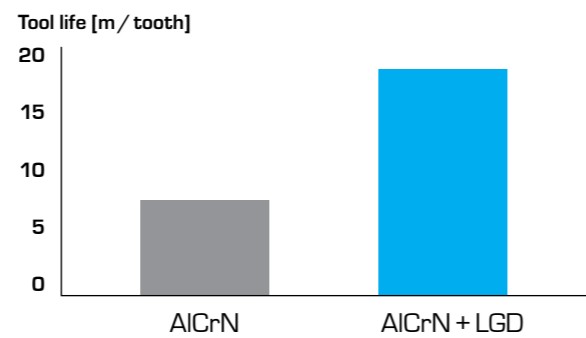

Tool: PM-HSS
Workpiece material: 20 MnCrB5
Module: 2.7 mm; downhill milling; dry
vc = 220 m/min; fa = 3.6 mm/rot
Source: 2-tooth test at the University Magdeburg, Germany

3D etch indicator

Our patented 3D etch indicator is a method for visual observation of the plasma etching efficiency and quantification thereof. It allows dedicated processes and parameters for shank tools, gear cutting tools, dies or even for complex geometries.

Highlights:

- Provides a 3D profile of the plasma etching efficiency
- Prevents both, insufficient etching and over-etching
- Boosts the performance of coatings in targeted applications

To obtain a 3D etch profile, the tools are covered with thin films reflecting homogeneously a single interference color (e.g., blue). The plasma etching procedure will be carried out. In accordance with interference colors scale [1], observed color changes over etched surfaces depict etching efficiency on each of them. Therefore, a complete 3D etch profile over the substrate with a high resolution (± 5 nm) is generated.

PLATIT's 3D plasma etch indicator enables to select the right combination of etching technologies as well as the parameters and ensures that the selected etching strategy leads to optimum material removal from the substrate surface. While conventional optimization of plasma etching is only feasible for 1D or 2D measurements and requires feedback from performance tests, with the 3D etch indicator, feedback is visible to the naked eye immediately after the plasma etch test.

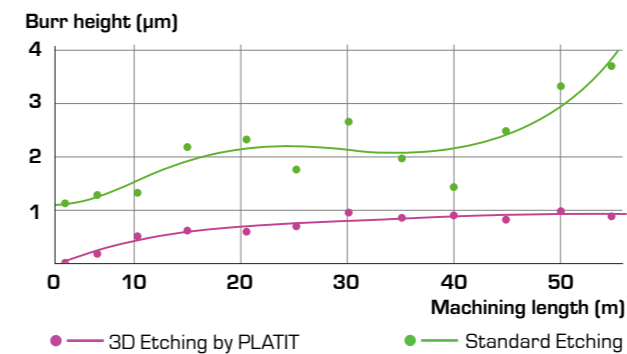

The graph shows the result of a dedicated etching optimization: the burr height of the micro tool coating with optimized etching is much lower compared to the standard plasma etching.

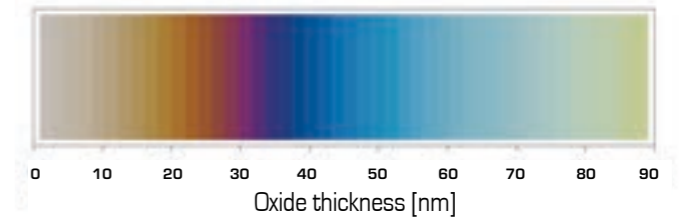

Interference color scale from [1] Antończak, A. J., et al. (2014). The influence of process parameters on the laser-induced coloring of titanium. Applied Physics A, 115(3),1003–1013

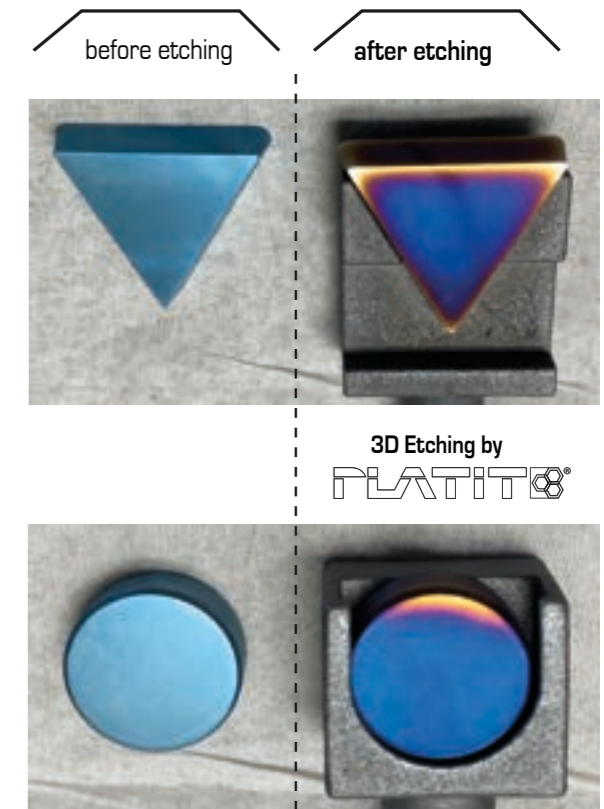

3D Etching by
PLATIT®

Inhomogeneous removed material



Coating technologies

ARC

- The benchmark for standard tooling applications
- Highest ionization and plasma density, best productivity
- Very competitive costs per tool
- Typical applications: mills, drills, inserts, hobs, saw blade

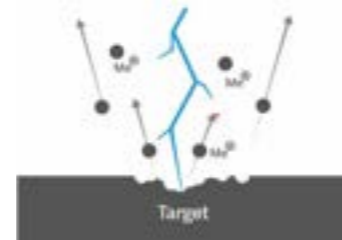

LARC

- **L**ateral **R**otating **C**athodes for cathodic arc evaporation in PLATIT Pi-units
- Rotating cathodes enable high evaporation power, maximum flexibility and process control, prolonged target lifetime, homogeneous thickness distribution and improved adhesion by LGD etching

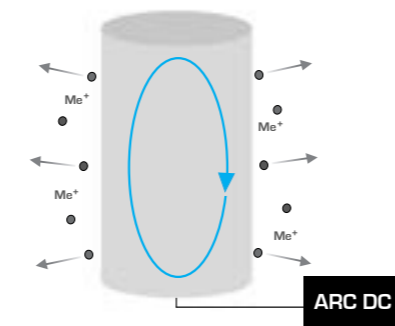

SAT

- Revolutionary double-pulsed feature of **S**upreme **A**rc **T**echnology energizes arc cathodes with two simultaneously used high-current, medium-frequency power sources (DC, pulsed), resulting in a highly dense and strongly ionized plasma
- Next to cutting-edge performance, coatings deposited by SAT show reduced roughness, exceptionally high deposition rates, maximum efficiency (target and energy consumption) and cost-effectiveness

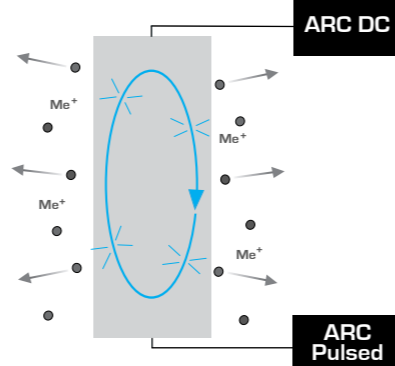

Hybrid

- Hybrid LACS (**L**ateral **A**rc with **C**entral **S**puttering) technology with simultaneous ARC and sputtering deposition – unique on Pi411 G3. Unlocks the best features of both technologies

LACS

- High-performant arc coatings, selectively doped or topped with ceramics and non-metal targets, e.g., B, C, V
- Cutting-edge sputtered (SCIL, FMS) coatings, improved in plasma density and adhesion by LARC technology
- Combination of both for functionality and higher productivity

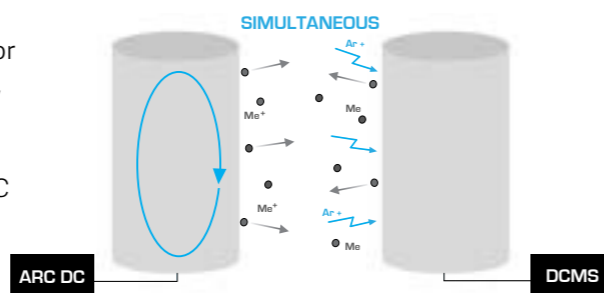

SPUTTER

- Ideal for depositing materials with low or no electrical conductivity, and ceramics
- Common base technologies (supplies): DCMS, HiPIMS
- Smooth coatings with low residual stress. Preserve edge geometry on sharp tools
- Typical applications: micro tools, taps, aluminum machining tools

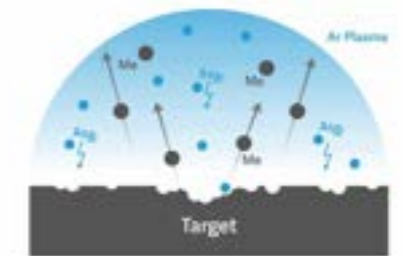

FMS

- Revolutionary patented **F**ocused **M**agnetron **S**puttering technology: Cathode's sputtering power is concentrated in a constantly moving small region ("ring") with very high target power density
- Productive 360° deposition from central position in carousel with maximum target utilization and coating homogeneity
- Dense plasma and high ionization rates (like HiPIMS), but with considerable faster deposition rates (like DCMS). Cost-efficient industrial setup for highest demands towards coating performance.

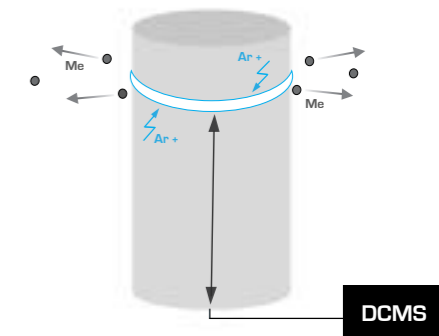

SCIL

- Highly productive setup with one DCMS source connected to a central sputtering cathode
- Central SCIL cathode with performant integrated cooling cycle and close distance to substrate allows high deposition rates in strongly ionized plasma induced by LGD from LARC cathodes

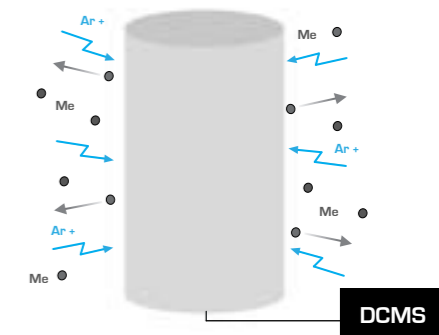

TRM

- The unique **T**win **R**otating **M**agnetron concept consists of one high performance HiPIMS source that is powering two LARC RM cathodes in bi-pulse mode
- TRM technology enables active pulse control (length and voltage, also asymmetric). Constantly switch anode and cathode and rotating magnetrons guarantee stability and enable high power inputs
- Smooth, droplet-free coatings are deposited in cost-effective setup

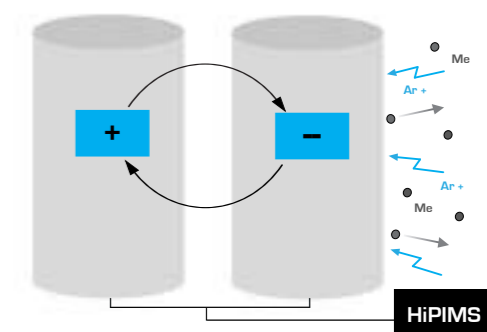

Signature technologies

Rotating cathodes

All of PLATIT's Pi-series equipment operate with PLATIT's revolutionary and patented rotating cathode technology (LARC, SCIL, FMS). For both ARC

evaporation and SPUTTERING technologies (DCMS, HiPIMS) there are major advantages of rotating cathodes.

LARC® for ARC or DC deposition

FMS or SCIL® for SPUTTER technology

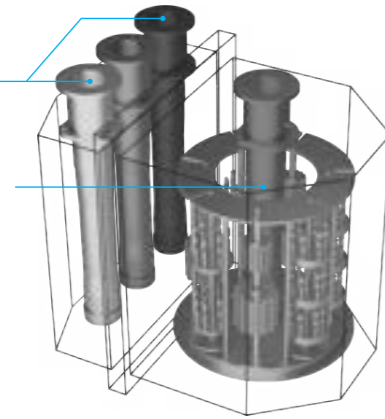

Compared to conventional cathodes, rotating cathodes have several advantages:

- Flexibility in programming the coating composition of unalloyed targets
- A larger effective target surface area ($\pi \times d$) at a constant target length h ($\pi \times d \times h$) prolongs target lifetime (please see the target performance comparison below)
- Excellent process control and stability
- Improved coating adhesion through LGD® etching (Lateral Glow Discharge)
- Homogeneous vertical coating thickness distribution in the chamber
- All the rotating cathodes in PLATIT's Pi coating units have a lifetime warranty when regularly exchanged in PLATIT Cathode Exchange Centers

Target performance comparison:

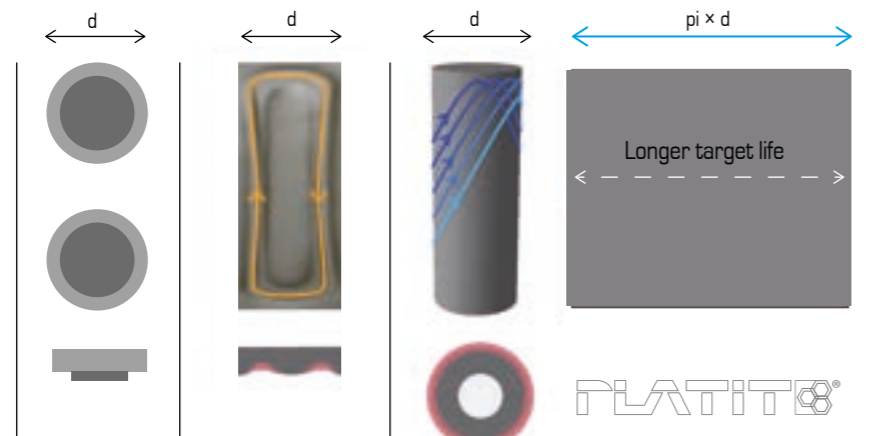

Spot	Planar	Cylinder	Target types
★★☆☆☆	★★★★☆	★★★★★	Homogeneity (coating thickness distribution)
★★☆☆☆	★★★★☆	★★★★★	Efficiency in target utilization

Coating structures



Monoblock (MB) consists of a single layer of nitride. This single layer can be applied on an adhesion layer (e.g. TiN + AlTiN-MB). If the adhesion layer and monoblock do not differ, the coating process does not switch between different target materials.



Gradient (G) occurs if the composition in the coating continuously changes. The coating consists of an adhesion and a core layer. A typical G coating is TiAlN/AlTiN-G.



Nanolayer (NL) is a finer version of a multilayer with a layer thickness of < 20 nm. Coating hardness depends on the coating thickness period. To increase the hardness, a period of approx. 10 nm should be set. All PLATIT coatings with metallic targets have a NL structure.



Multilayer (ML) also consists of an adhesion and a core layer. After the adhesion layer, several layers are deposited in succession. These multiple layers create a sandwich structure that absorbs the cracks in the sublayers. The coating is tougher but not as hard as a monoblock. The thickness of a single layer in ML is typically 50–100 nm, as for example in AlCrN-ML.

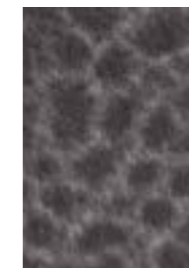

Nanocomposites (NC) consist of an adhesion and a core layer. The core layer consists of 2 phases: hard, nanocrystalline grains (e.g. TiN, TiAlN or AlCrN grains) are embedded in an amorphous SiN matrix, which prevents the grain from growing and creates the nanocomposite structure. Column growth is prevented and a fine crystalline/amorphous structure is formed. One example is nACo.

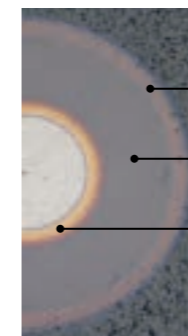

Nanocomposite top layer
Monoblock or gradient core layer
Adhesion layer

TripleCoatings3 from PLATIT consist of an adhesion layer, a core layer (MB or G) and a nanocomposite top layer. A typical coating is nACo, available with the Pi411 coating unit.

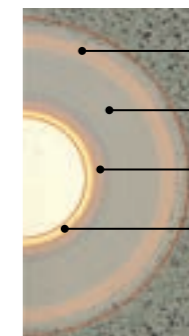

Nanocomposite top layer
Multilayer core layer
Gradient core layer
Adhesion layer

QuadCoatings4 from PLATIT receive a fourth block for special purposes in addition to the triple structure. These coatings consist of an adhesion layer, a first core layer of the gradient type, a second core layer of the multilayer type and a nanocomposite top layer. A typical example is TiAlloy-X.

Coating structures

Comparison of the structure

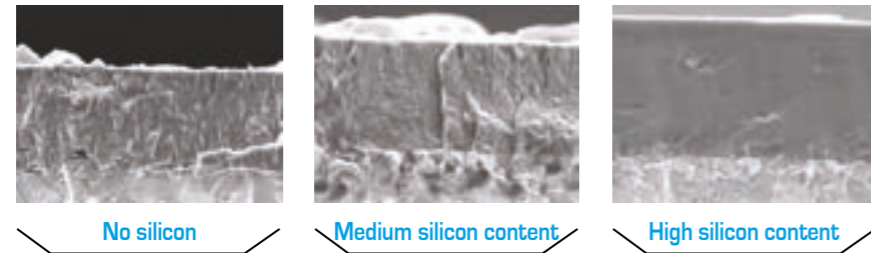

A comparison with sand on a beach can serve to illustrate the increase in hardness achieved by the nanocomposite structure: normally, a person's foot will sink into dry sand. If the sand is wet, their foot

will not sink in as far, because the space between the grains is filled with water. The surface has a higher resistance and is therefore harder.

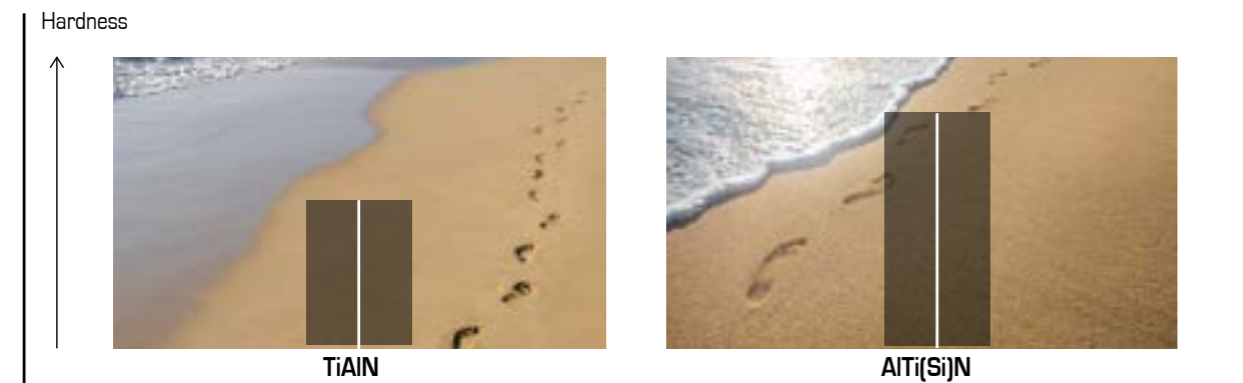

Heat resistance comparison of nanocomposite:

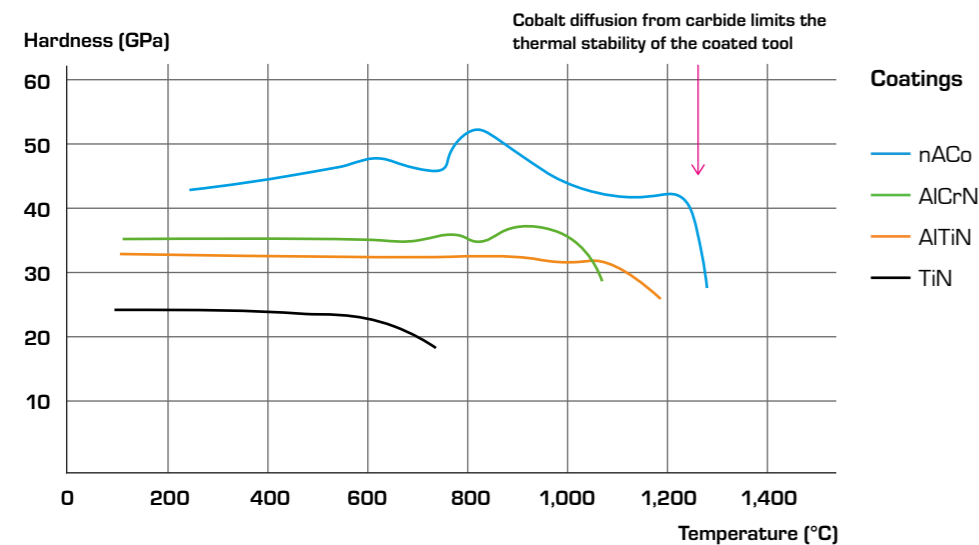

DLC coatings

DLC (diamond-like carbon) is a metastable form of diamond-like amorphous carbon with a significant amount of sp³ bonds.

The higher sp³ bond fraction results in a higher density, hardness (at ambient and elevated temperature), thermal stability, oxidation resistance and lower thermal conductivity.

Properties and application possibilities:

- Smooth surface
- High mechanical hardness
- Chemical resistance
- Lowest coefficient of friction between the tool and the workpiece
- Good corrosion resistance
- Non-reflective surface
- Suitability for biocompatible products

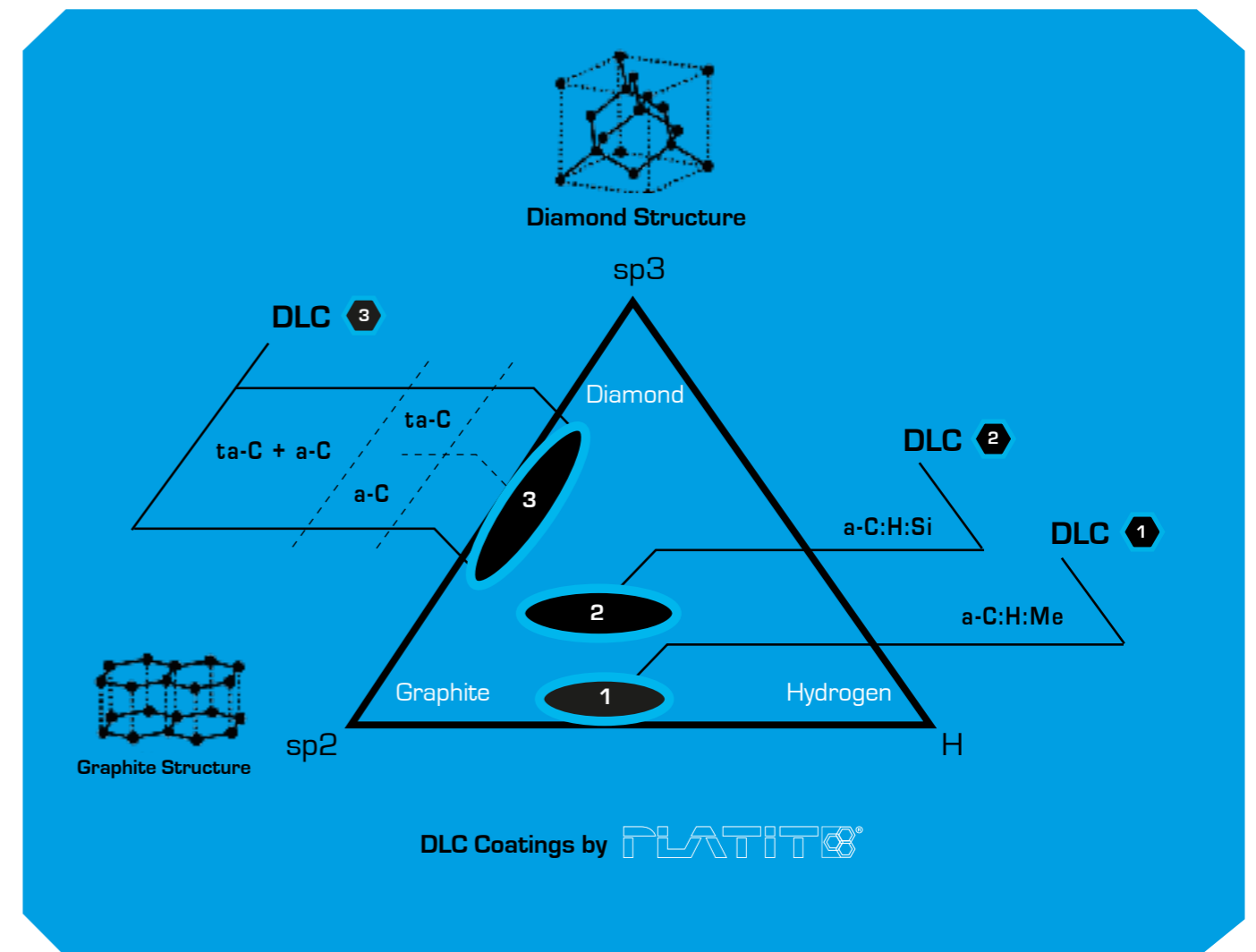

DLC coatings

DLC coatings are divided into the following categories:

- a-C = hydrogen-free amorphous carbon
- ta-C = tetrahedrally bound hydrogen-free amorphous carbon
- a-C:Me = metal-doped hydrogen-free amorphous carbon (Me = Ti)
- a-C:H = amorphous carbon with hydrogen
- ta-C:H = tetrahedrally bound amorphous carbon with hydrogen
- a-C:H:Si = Si-doped amorphous carbon with hydrogen
- a-C:H:Me = metal-doped amorphous carbon with hydrogen (Me = W, Ti, Cr)

Comparison of the most important properties of PLATIT DLC coatings

	DLC 1	DLC 2	DLC 3
PLATIT coating unit	111 G3 411 G3 1011 SAT	411 G3 1011 SAT	111 TRM 411 G3
Composition	a-C:H:Me	a-C:H or a-C:H:Si	ta-C + a-C (over 50% ta-C)
Process	ARC in C ₂ H ₂ atmosphere	PECVD and / or SPUTTERING	SPUTTERING
Coating architecture	As top layer	As stand-alone or as top layer	As stand-alone or as top layer
Doping	Ti or Cr	Si or none	None
Coating thickness [µm]	< 1	< 3	0.3–1
Young's modulus [GPa]	200	250	350–450
Nano-hardness [GPa]	< 20	> 25	35–55
Roughness	Ra ~ 0.1 µm Rz ~ coating thickness	Ra ~ 0.03 µm Rz ~ coating thickness	Ra ~ 0.06 µm Rz ~ coating thickness
Coefficient of friction [µ] PoD (at RT, 50% humidity)	~ 0.15	~ 0.1–0.2	~ 0.1
Max. service temperature [°C]	400	400	450
Coating temperature [°C]	< 400	< 220	< 100
Main application	Improvement of the run-in process of a tool, lubrication by formation of transfer films	Components, punches and dies	Tools

STANDARD COATING UNITS



PLATIT® 11-Series

PLATIT 11-Series overview

PLATIT offers high-tech PVD and PECVD coating units. Depending on the requirements, we equip them with the following technologies:

- ARC in DC or pulsed mode
- SPUTTER in DC or pulsed mode
- HiPIMS
- Focused Magnetron Sputtering FMS
- Hybrid technology with simultaneous ARC and SPUTTER processes

PVD standard coating units from PLATIT are perfectly suited for coating tools and components of standard market sizes. They allow for short cycle times with high-quality coatings and can be flexibly programmed with different coating structures.

Standard coating units can deposit PVD and PECVD for various nitride, oxide and DLC coatings.

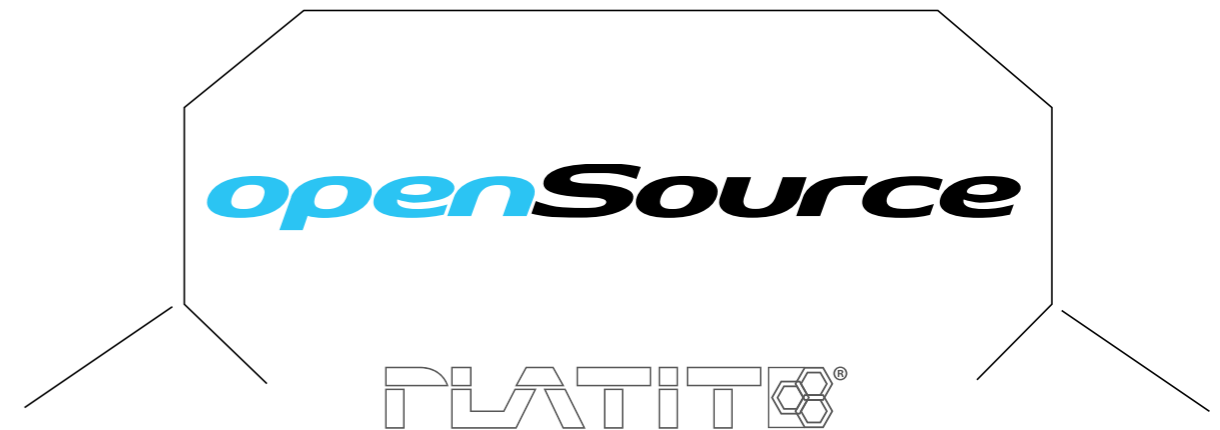

PLATIT® 11 - Series

	Pi111 G3	Pi111 TRM	Pi411 G3	PL1011 SAT
Max. coating volume [mm]	∅ 353 × H 498	∅ 353 × H 498	∅ 540 × H 500	∅ 715 × H 805
Max. load [kg]	160	160	200	750
Load and cycle times of shank tools (2 μm): ∅ 8 × 70 [mm]*	288 pcs., 4–5 h	288 pcs., 6 h	504 pcs., 5–6 h	1,008 pcs., 5.5–6.5 h
ARC technology cathodes	2 × LARC PLUS	-	3 × LARC AFM	4 × Planar
SPUTTERING (DCMS, HiPIMS) technology cathodes	-	2 × LARC® RM, HiPIMS	Upgradable with: 1 × central SCIL 1 × central FMS 1 × LARC RM (door, pos.2)	-
Hybrid-LACS® technology with simultaneous ARC & SPUTTER processes	-	-	Yes, upgradable	-
DLC	Upgradable for DLC1 with TiCN option	ta-C sputtering (DLC3)	DLC1, upgradable for ta-C sputtering (DLC3), PECVD (DLC2)	DLC1, upgradable for PECVD (DLC2)
OXI	-	-	Upgradable for oxide coatings	-

* Average cycle times in an ongoing production with max. number of cathodes in use.

111

411

PLATIT® 11 - Series

711

1011

1511

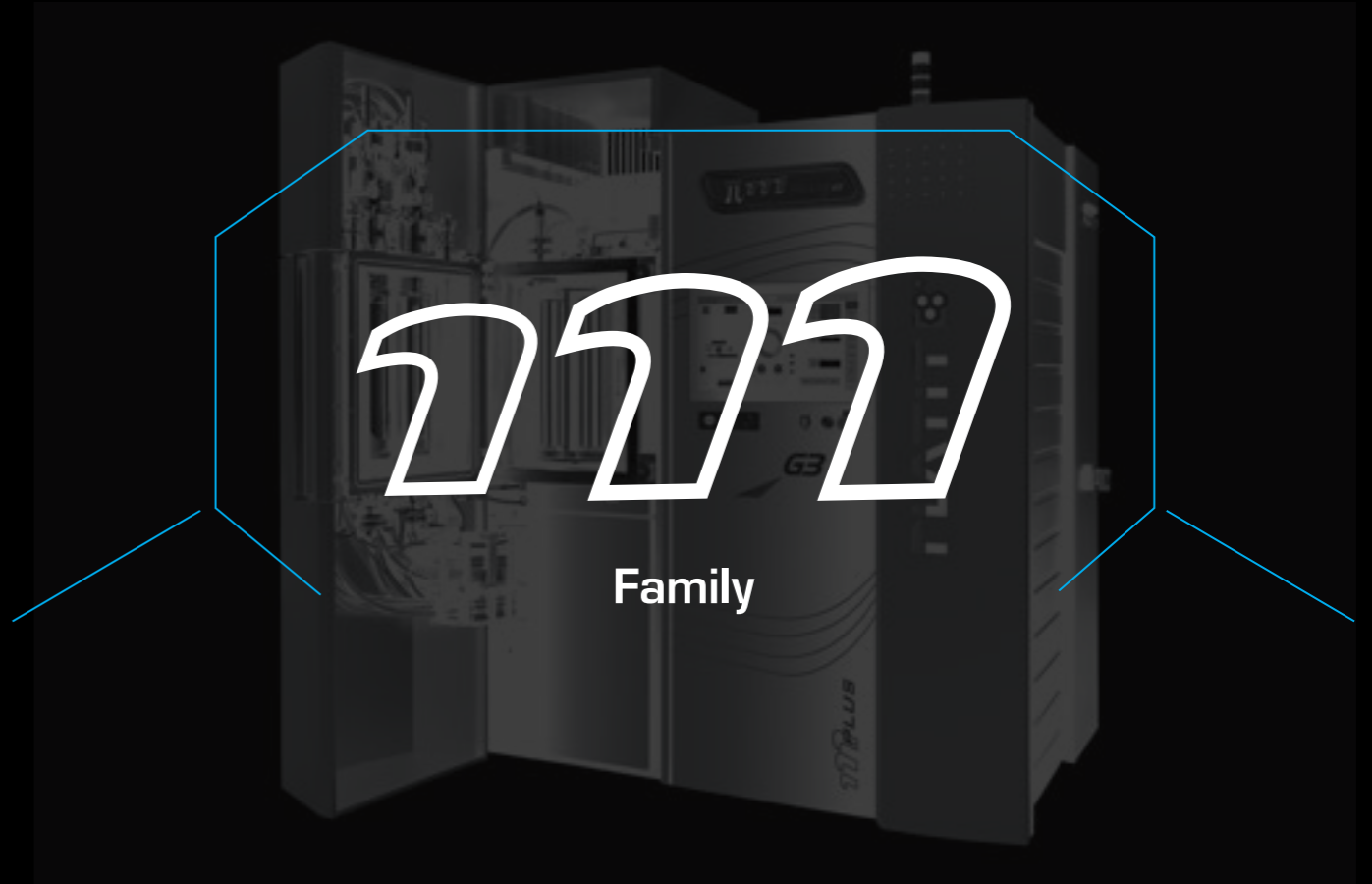

Family



PLATIT® 11 - Series

111 G3

- A** LARC® PLUS Cathode
- B** LARC® PLUS Cathode
- C** Carousel

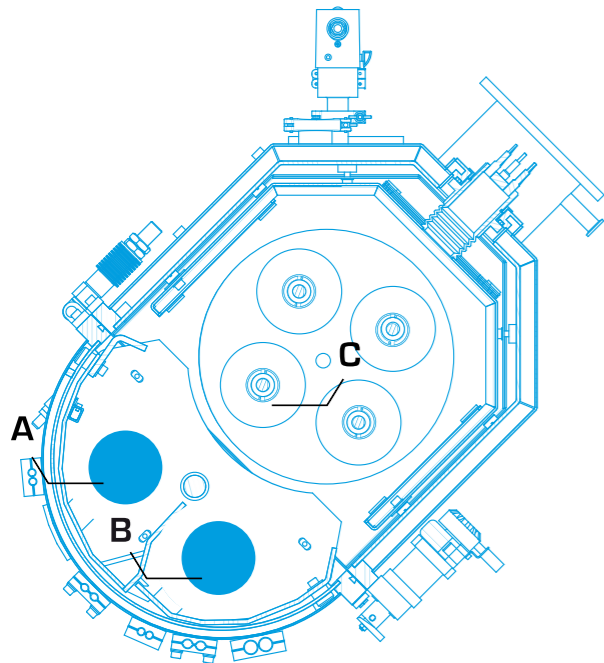

- Technologies applied:**
- 2 × LARC PLUS (Lateral Rotating PLUS Cathode) for ARC deposition
 - Upgradable with TiCN option for DCL1 Coatings

- Highlights:**
- PLATIT Signature Technologies: Rotating Cathodes and LGD etching
 - Selective cutting-edge PLATIT Signature Coatings on highest performance level
 - Smart system: productive, fast and easy-to-use

PLATIT 8



The Pi111 G3 represents the third generation of a compact PVD coating unit from PLATIT. Its key features are fast cycle times, easy operation and user-friendliness at a favorable price – without compromising coating performance. Having two rotating cathodes utilizing ARC technology, the unit deposits selected PLATIT Signature Coatings at a consistently high level of quality. It is the ideal choice for customers looking to enter the coating world or wanting to add a fast low-volume PVD system to their fleet of machines.

Cathodes
2



Signature Coatings



Cycle
≥ 4 h



Max. Load
160 kg



Solution
Turnkey



Service
Worldwide



111 Twin Rotary Magnetron



The Pi111 TRM (Twin Rotary Magnetron) is a state-of-the-art HiPIMS PVD coating unit featuring PLATIT's Twin Rotary Magnetron technology. Its two rotating sputter cathodes with advanced magnetron technology deliver dense, droplet-free coatings that are especially valuable for micro tools and demanding applications such as reamers and taps. The Pi111 TRM ensures superior coating performance and flexibility. Ideal for manufacturers seeking a fast, efficient sputtering machine with the latest technology at a reasonable cost, the Pi111 TRM is the perfect addition to any coating operation.

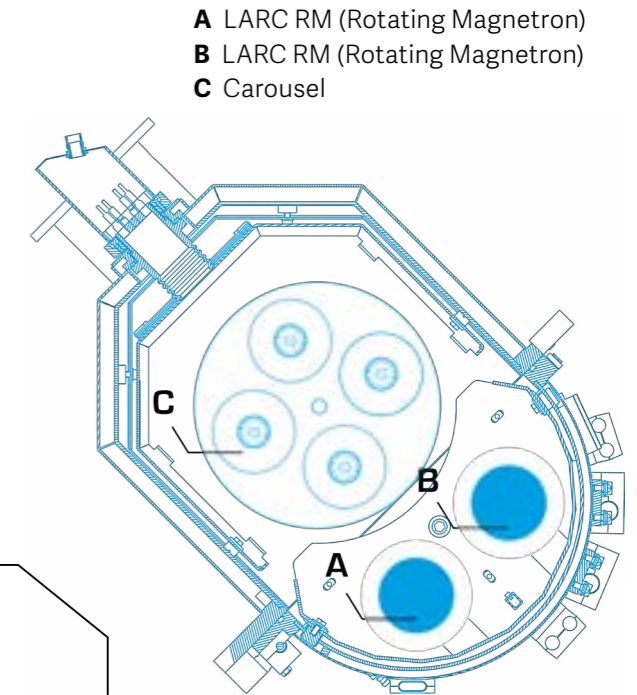

Technologies applied:

- 2 × LARC RM (Rotating Magnetron)

Highlights:

- High-powered rotating cathodes
- Wide range of materials and coatings to fit the applications needs
- Dense coatings thanks to the high power pulsing for challenging applications such as micro tools
- Smooth droplet free coatings
- Targets can include both metals and low or no electrical conductivity materials, such as ceramics
- Bi-pulse HiPIMS technology provides active control of pulse and ion distribution, making even low-temperature processes possible
- Generation of highly energetic ions with strong impact for excellent coating adhesion and properties

Cathodes
2



Signature Coatings



Cycle
≥ 4 h



Max. Load
160 kg



Solution
Turnkey



Service
Worldwide



111 Family

Specifications

Etching technologies applied:

- LGD (Lateral Glow Discharge)
- Plasma etching with argon, glow discharge
- Metal ion etching (Ti, Cr)

Load and cycle times:

- Max. coating volume: 353 × H 498 [mm]
- Max. coating height with defined coating thickness: 414 mm (Pi111 G3), 380 mm (Pi111 TRM)
- Max. load: 160 kg

Batch times Pi111 G3*:

Shank tools (2 µm):	∅ 10 × 70 [mm]	288 pcs.	4–5 h
Inserts (3 µm):	∅ 12 × 4 [mm]	2,736 pcs.	5–6 h
Hobs (4 µm):	∅ 75 × 120 [mm]	30 pcs.	6–7 h

* Average cycle times in an ongoing production with max. number of cathodes in use.

Batch times Pi111 TRM*:

Micro tools (0.5 µm):	∅ 3 × 50 [mm]	1,280 pcs.	≈ 4 h
Shank tools (2 µm):	∅ 10 × 70 [mm]	288 pcs.	≈ 6 h

* Average cycle times in an ongoing production with max. number of cathodes in use.

Modular carousel systems:

- 1 or 4 or 10 axes

Software:

- Simple use and maintenance
- PLATIT SmartSoftware (PC and PLC system)
- Modern control system with touch screen
- Data recording and real-time display of process parameters and flow
- Manual and automatic process control
- Remote diagnostics and maintenance

Machine dimensions:

- Footprint: W 1,930 × D 1,560 × H 2,220 [mm]

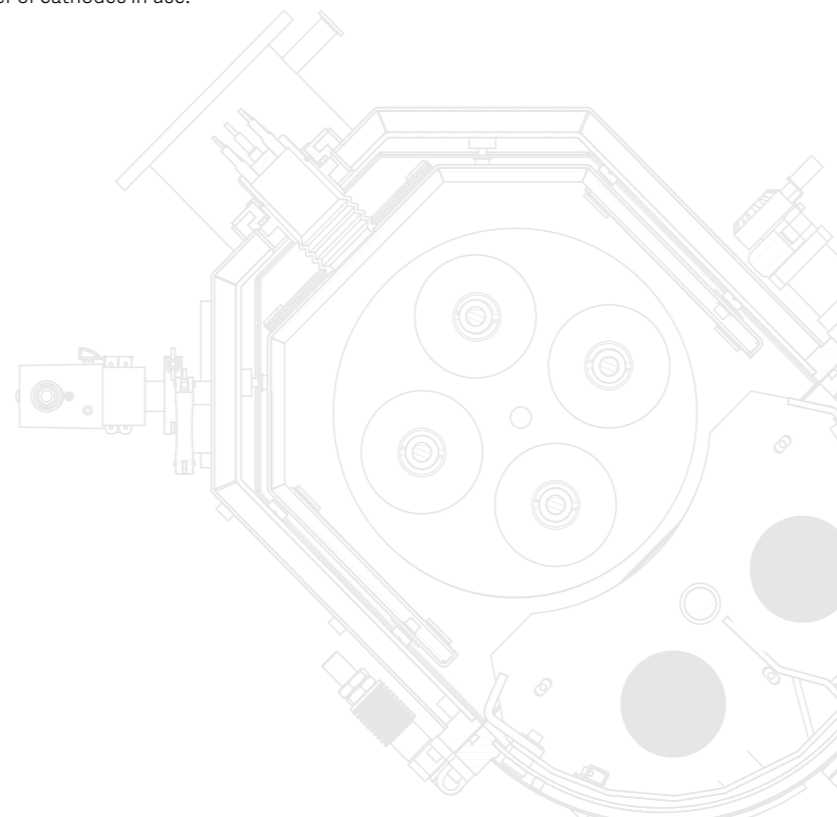

PLATIT® 111 - Series

411 Ultra Flexible Unit

The broad variety of configuration options as well as the flexibility made possible by the rotating cathodes allows for the development of customer-specific top-performance coatings. Thus, this coating unit addresses the needs of customers who are seeking maximum flexibility with a full range of coating technologies easily accessible in one machine.

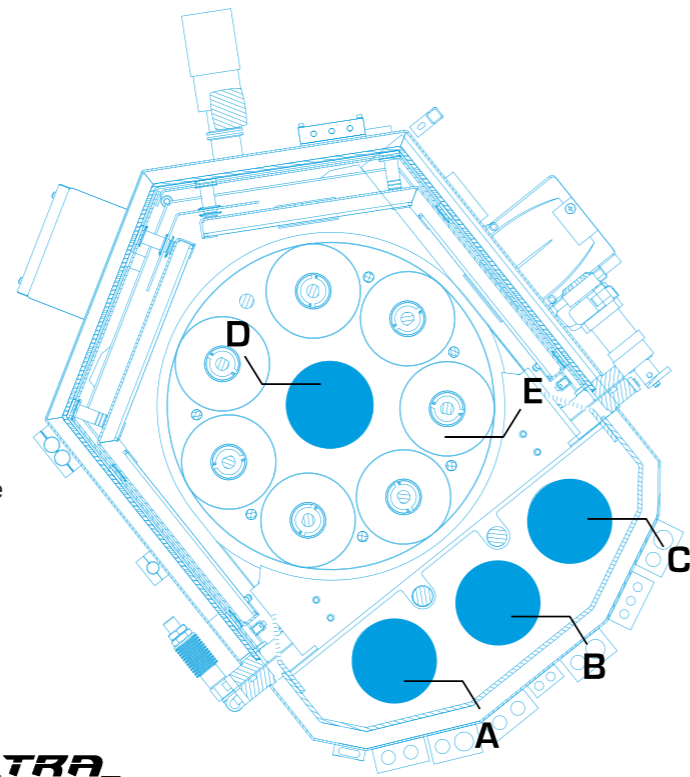

- A** LARC AMF Cathode
- B** LARC AMF Cathode or LARC RM Cathode
- C** LARC AMF Cathode
- D** Optional SCIL or FMS Cathode

411 ULTRA Flexible



Due to its modular design and the range of available technologies, the Pi411 G3 is the world's most flexible coating unit. Its basic configuration as an ARC unit with three rotating cathodes inside the door can be modularly upgraded on-site with SPUTTER technology (SCIL, FMS, LARC RM cathodes) as well as with PECVD and OXI processes. Unique to this unit is also the availability of LACS hybrid technology, which allows for the simultaneous deposition of coatings using both ARC and SPUTTER technology.

Options for Pi411 G3



ECO: Basic configuration with 3 × LARC AMF (Lateral Rotating Cathode with Adjustable Magnetic Field) inside the door for ARC deposition

LARC RM (Rotating Magnetron): Integrated SPUTTERING cathode in the door enables complementary deposition steps and compact system design for multi-process flexibility

SCIL (SPUTTERED Coating Induced by Lateral Glow Discharge): High-performance SPUTTERING from the central cathode

FMS (Focus Magnetron Sputtering): High-density SPUTTERING from the central cathode with enhanced coating performance and efficiency

Hybrid LACS: Simultaneous ARC and SPUTTER processes with LARC AMF inside the door and a central SCIL cathode

PECVD (DLC2): For a-C:H:Si coatings

OXI: For oxide coatings in a corundum structure

Cathodes 3 - 4	Hybrid LACS®	Signature Coatings	Cycle ≥ 5 h	Max. Load 200 kg	Solution Turnkey	Service Worldwide

411 Ultra Flexible Unit

FMS: High-performance sputtering cathode with maximum efficiency

Focused Magnetron Sputtering (FMS) is a breakthrough innovation. The cathode's sputtering power is concentrated in a constantly moving small region ("ring") with very high target power density. This results in a dense plasma with high ionization rates,

while at the same time delivering significantly faster deposition rates. With both superior performance and productivity, the patented FMS technology sets the new benchmark for DCMS and HiPIMS coatings for tools and components.



Industrial relevance and comparison to existing technologies

By simultaneously achieving HiPIMS-level plasma densities and DCMS-like productivity, FMS outperforms both and presents itself as a viable alternative to arc evaporation—without its drawbacks, such as droplet formation. FMS introduces new capabilities to the coating industry. By providing a stable, robust, and cost-effective process, it sets a new benchmark in sputtering technology—offering enhanced coating performance, increased productivity, and greater industrial scalability.



Highlights:

- **High plasma density:** FMS concentrates power into a small region ("ring"), resulting in 40x higher target power density than DCMS – a range that can otherwise only be achieved by HiPIMS technology. Due to the high plasma density of FMS, coating properties result in higher hardness as well as improved wear and corrosion resistance.
- **Higher deposition rate:** FMS has a higher deposition rate compared to HiPIMS technology, as it compresses the plasma spatially to achieve high ionization rates rather than concentrating power into short pulses. This enables FMS for industrial applications with high demands towards productivity and makes it a viable alternative to arc evaporation.



- **Enhanced coating homogeneity and reduced material loss:** The focused plasma minimizes uncontrolled particle formation, improving coating quality and purity. Thanks to the central cathode placement and unique magnetic confinement design of FMS (360° deposition), FMS ensures minimal target material loss and enhances coating efficiency.
- **Coating thickness uniformity:** By continuously moving the magnetic field vertically, the FMS technology ensures precise control of the coating thickness over the substrate height.
- **Higher ionization rates at lower costs:** FMS delivers high ionization degree without the need for expensive HiPIMS power supplies. Combined with its higher productivity, it achieves significantly lower costs per tool for high-end PVD coatings in comparison to HiPIMS technology.



411 Ultra Flexible Unit

Specifications

Etching technologies applied:

- LGD (Lateral Glow Discharge)
- Plasma etching with argon, glow discharge
- Metal ion etching (Ti, Cr)

Load and cycle times:

- Max. coating volume: \varnothing 540 × H 500 [mm]
- Max. coating height with defined coating thickness:
400 mm (ECO), 345 mm (SCIL), 420 mm (FMS)
- Max. load: 200 kg

Batch times Pi411 G3*:

Shank tools (2 μ m):	\varnothing 10 × 70 [mm]	504 pcs.	5–6 h
Inserts (3 μ m):	\varnothing 12 × 4 [mm]	4,788 pcs.	6–7 h
Hobs (4 μ m):	\varnothing 80 × 120 [mm]	42 pcs.	7–8 h

* Average cycle times in an ongoing production with max. number of cathodes in use.

Modular carousel systems:

- 1 to 14 axes

Software:

- Simple use and maintenance
- PLATIT SmartSoftware (PC and PLC system)
- Modern control system with touch screen
- Data recording and real-time display of process parameters and flow
- Manual and automatic process control
- Remote diagnostics and maintenance

Machine dimensions:

- Footprint: W 2,950 × D 1,900 × H 2,400 [mm]

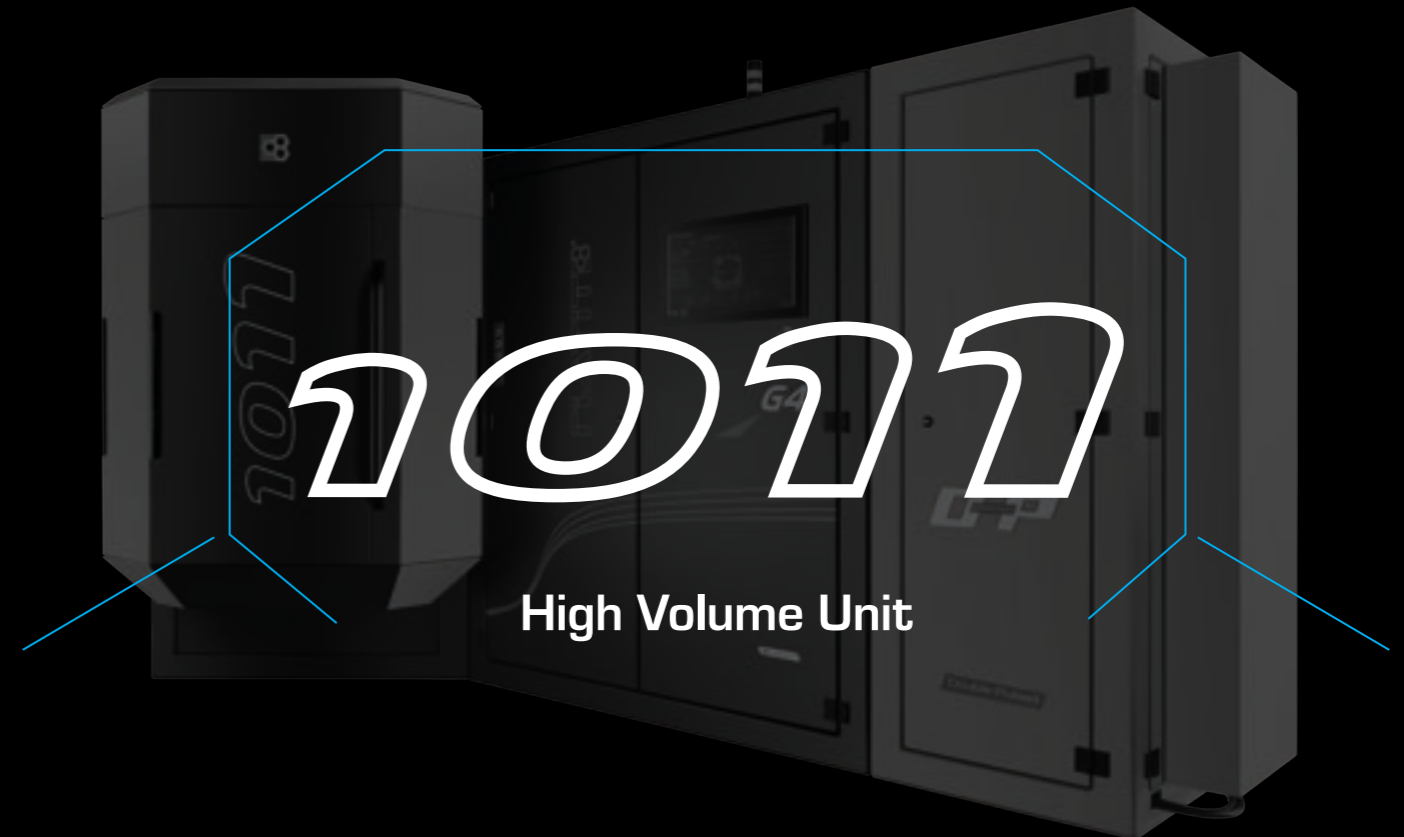
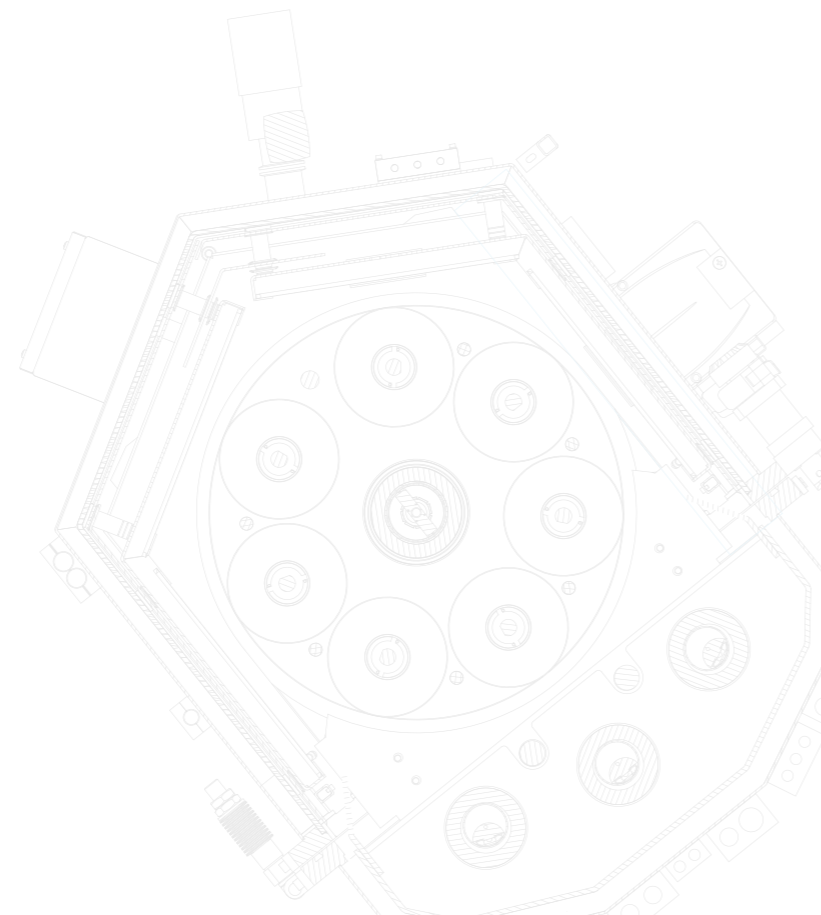

PLATIT® 11-Series

1011 SAT

The PL1011 SAT (Supreme Arc Technology) with revolutionary double-pulsed technology features four planar arc cathodes and eight arc power supplies, setting a new standard in PVD coating. As the next generation of PLATIT's robust coating units, it serves as the backbone of any high-volume coating center.

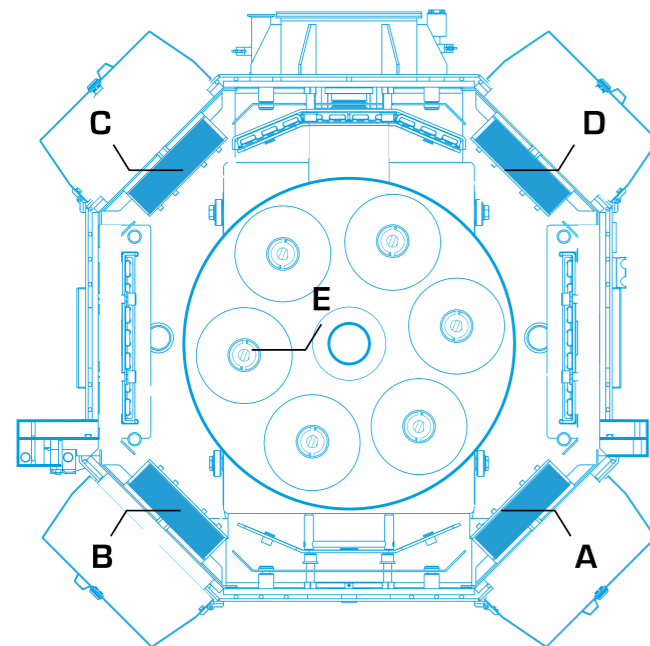

- A Planar Cathode
- B Planar Cathode
- C Planar Cathode
- D Planar Cathode
- E Carousel

Technologies applied:

- 4 x Planar ARC cathode with 8 x ARC power supplies in both DC and pulsed modes



Engineered for customers who prioritize both process reliability and high deposition rates, the PL1011 SAT delivers premium-quality coatings at low costs per tool. Its industrial design maximizes service accessibility, making maintenance efficient and user-friendly.

Double-Pulsed technology

The PL1011 SAT with revolutionary double-pulsed technology sets a new benchmark in PVD coating. Traditional arc evaporation, while enabling high deposition rates through high currents, often leads to rougher coatings. In contrast, the PL1011 SAT achieves a significantly smoother surface with minimal droplet formation.

What sets this technology apart is its ability to generate a highly dense, strongly ionized plasma by combining advanced high-current medium-frequency power sources for pulsed arc with improved cathode technology for superior arc steering. The result is a dense, high-quality coating with reduced roughness, delivering outstanding surface quality.

This advanced double-pulsed technology offers exceptional efficiency, lower energy consumption, and shorter batch times thanks to enhanced evaporation rates. It also ensures a more uniform coating thickness across the entire height and optimizes target utilization.

Highlights

- Dense, ionized plasma using advanced power sources and enhanced cathode technology
- High productivity with 30 % faster coating deposition time
- Superior coating quality with a smoother surface and minimal droplet formation
- Optimized target utilization for increased efficiency and cost-effectiveness



Cathodes	Signature Coatings	Cycle	Max. Load	Solution	Service
4		≥ 5.5 h	750 kg	Turnkey	Worldwide

1011 SAT

Specifications

Etching technologies applied:

- LGD (Lateral Glow Discharge)
- Plasma etching with argon, glow discharge
- Metal ion etching (Ti, Cr)

Load and cycle times:

- Max. coating volume: \varnothing 715 × H 805 [mm]
- Max. coating height with defined coating thickness: 750 mm
- Max. load: 750 kg; higher weight upon request

Batch times PL1011 SAT*:

Shank tools (2 μ m):	\varnothing 10 × 70 [mm]	1,008 pcs.	5.5–6.5 h
Inserts (3 μ m):	\varnothing 12 × 4 [mm]	11,760 pcs.	7–7.5 h
Hobs (4 μ m):	\varnothing 120 × 120 [mm]	72 pcs.	6–6.5 h

* Average cycle times in an ongoing production with max. number of cathodes in use.

Modular carousel systems:

- 1 to 12 axes

Software:

- PLATIT SmartSoftware (PC and PLC system) with touch screen
- Statistics and help function via user interface
- Data recording and real-time display of process parameters and flow
- Manual and automatic process control
- Remote diagnostics and maintenance

Machine dimensions:

- Footprint: W 4,700 × D 2,250 × H 2,350 [mm]

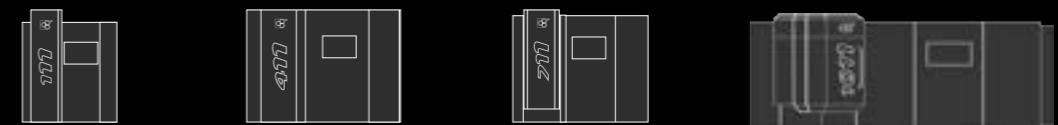
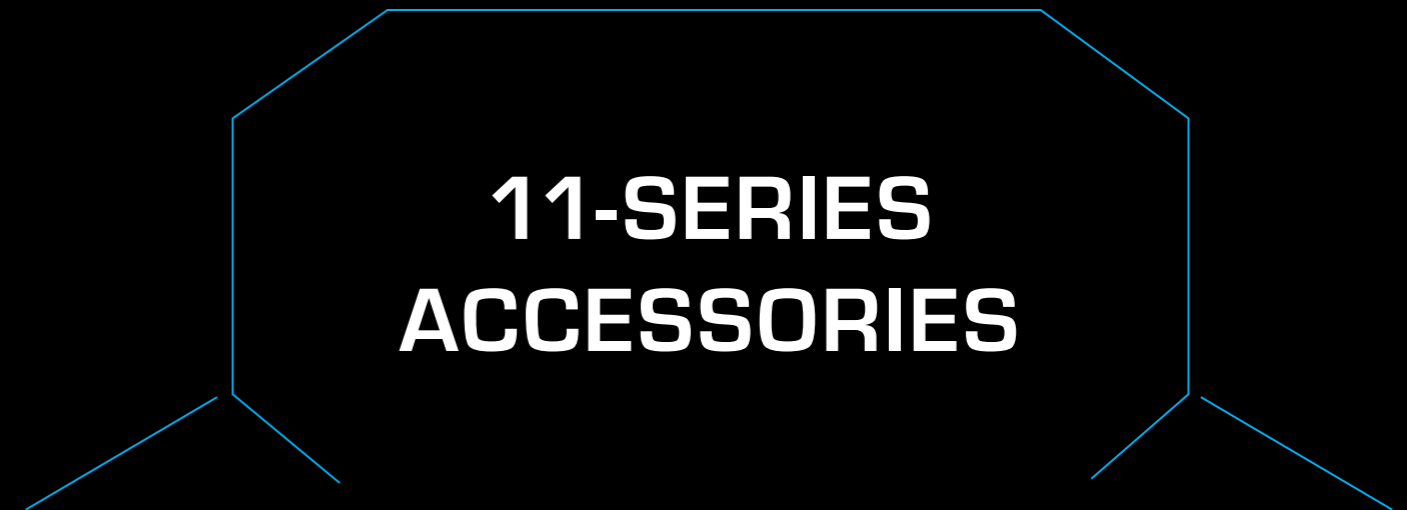
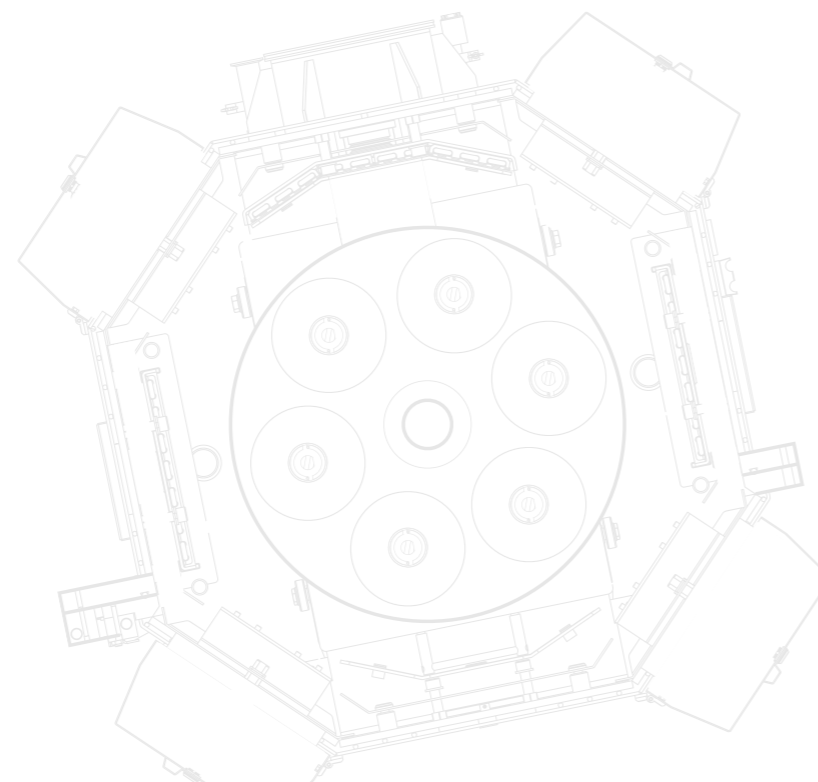

PLATIT® 11-Series

Loading capacities

Pi111 G3

Tool type	Tool diameter	Tool length	Satellites	Discs/satellite	Holders/disc	Tools/holder	Tools/disc	Tools/batch	Holder type
Mirco Tool	3 mm	48 mm	4	4	8	10	80	1,280	H
	6 mm	48 mm	4	4	8	6	48	768	H
Shank Tool	3 mm	50 mm	4	5	8	10	80	1,600	D
	6 mm	50 mm	4	4	5	9	45	720	G
	6 mm	50 mm	4	4	8	4	32	512	D
	6 mm	50 mm	4	4	18	1	18	288	A
	8 mm	60 mm	4	4	18	1	18	288	A
	10 mm	70 mm	4	4	18	1	18	288	A
	20 mm	100 mm	4	3	12	1	12	144	A
Insert	12 mm	4 mm	4	38	18	1	684	2,736	C
Hob	75 mm	120 mm	10	3	1	1	1	30	F
	140 mm	120 mm	4	3	1	1	1	12	F

Pi111 TRM

Tool type	Tool diameter	Tool length	Satellites	Discs/satellite	Holders/disc	Tools/holder	Tools/disc	Tools/batch	Holder type
Mirco Tool	3 mm	48 mm	4	4	8	10	80	1,280	H
	6 mm	48 mm	4	4	8	6	48	768	H
Shank Tool	3 mm	50 mm	4	4	8	10	80	1,280	D
	6 mm	50 mm	4	3	5	9	45	540	G
	6 mm	50 mm	4	4	8	4	32	512	D
	6 mm	50 mm	4	4	18	1	18	288	A
	8 mm	60 mm	4	4	18	1	18	288	A
	10 mm	70 mm	4	3	18	1	18	216	A
	20 mm	100 mm	4	3	12	1	12	144	A
Insert	12 mm	4 mm	4	38	18	1	684	2,736	C
Hob	75 mm	120 mm	10	3	1	1	1	30	F
	140 mm	120 mm	4	3	1	1	1	12	F

Pi411 ECO

Tool type	Tool diameter	Tool length	Satellites	Discs/satellite	Holders/disc	Tools/holder	Tools/disc	Tools/batch	Holder type
Micro Tool	3 mm	48 mm	7	4	8	10	80	2,240	H
	6 mm	48 mm	7	4	8	6	48	1,344	H
Shank Tool	3 mm	50 mm	7	4	8	10	80	2,240	D
	6 mm	50 mm	7	4	5	9	45	1,260	G
	6 mm	50 mm	7	4	8	4	32	896	D
	6 mm	50 mm	7	4	18	1	18	504	A
	8 mm	60 mm	7	4	18	1	18	504	A
	10 mm	70 mm	7	4	18	1	18	504	A
	20 mm	100 mm	7	3	12	1	12	252	A
Insert	12 mm	4 mm	7	38	18	1	684	4,788	C
Hob	80 mm	120 mm	14	3	1	1	1	42	F
	140 mm	120 mm	7	3	1	1	1	21	F

PL1011 SAT

Tool type	Tool diameter	Tool length	Satellites	Discs/satellite	Holders/disc	Tools/holder	Tools/disc	Tools/batch	Holder type
Shank Tool	6 mm	50 mm	4	7	15	4	60	1,680	E
	6 mm	50 mm	4	7	42	1	42	1,176	B
	8 mm	60 mm	4	7	42	1	36	1,176	B
	10 mm	70 mm	4	6	42	1	30	1,008	B
	20 mm	100 mm	4	5	23	1	23	460	B
Insert	12 mm	4 mm	4	2 × 35	42	1	1470	11,760	C
Hob	120 mm	120 mm	12	6	1	1	1	72	F
	140 mm	120 mm	10	6	1	1	1	60	F

Holder type:

- A Tool in a sleeve, driven by a gearbox
- B Tool in a sleeve, driven by a kicker
- C Insert with a hole, speared on a rod
- D Tool in a revolver, driven by a gearbox
- E Tool in a revolver, driven by a kicker
- F Hob on a satellite/rod
- G Tool in a sleeve, driven by a quad gearbox
- H Tool in a micro tool holder, driven by a gearbox

Process cost comparison

When calculating an investment in a PVD coating turnkey system, there are several variables to be taken into consideration. On this page we give you further insights about how fixed and variable costs add up for different PLATIT coating systems. We are using the case of a German SME coating 10 x 70 mm shank tools with three different coatings – AlTiN, Omnis and TiXCo3.

The diagram on the right visualizes that the majority of the batch costs of a PVD system are determined by the fixed costs. The main cost drivers are depreciation costs for the investment and the personnel costs for the operators. The variable costs, on the other hand, typically amount to less than one sixth of the total operating costs. In particular, the cost of the targets accounts for only 15–20% of the total cost per batch.

Cost per batch [CHF]:

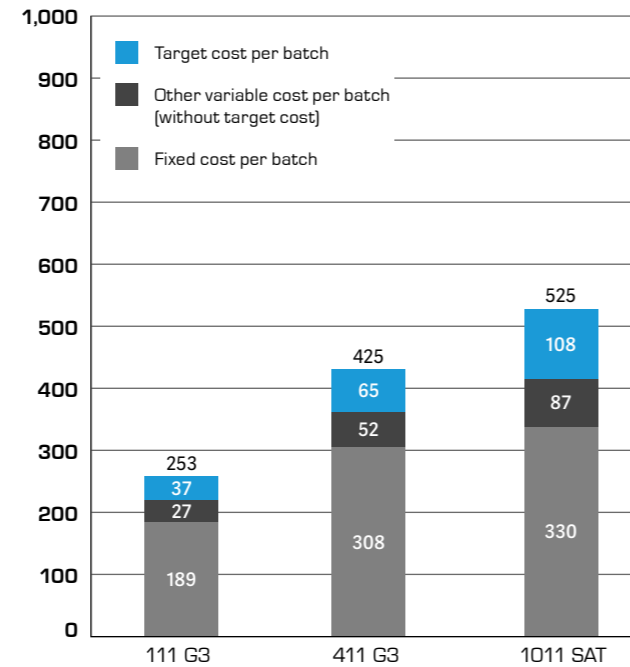

Cost per tool [CHF]:

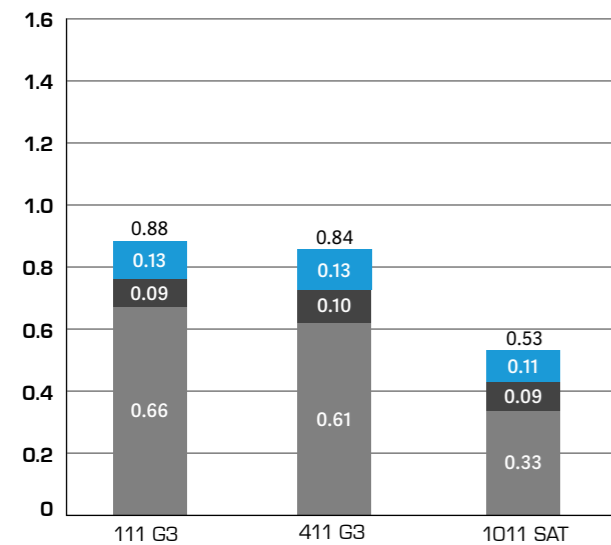

The diagram on the left visualizes the breakdown of cost per tool in different PLATIT coating systems. As it is shown in the diagram, the cost per tools decreases significantly in large-sized PVD coating units due to scale effects.

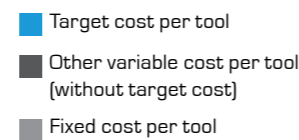

Detailed case description:
 German tool manufacturer, 10 x 70 mm shank tools
 Coatings: AlTiN (40%), Omnis (40%), TiXCo3 (20%), 2µm on tool
 Costs included:
 Fixed costs: Investment in PVD system incl. production accessories, depreciation (8 years), operator wages (240 working days per year: 5am to 11pm), rental costs for space, unit maintenance
 Loading: Pi111 = 288 pc; Pi411 = 504 pc; PL1011 = 1008 pc.

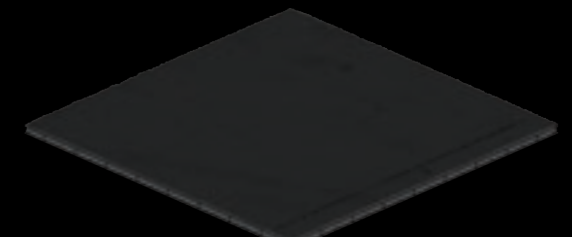
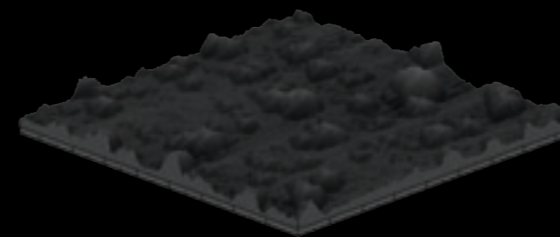

Cathode configurations

Coatings	111 G3 2 × LARC PLUS, TiCN option available		111 TRM 2 × LARC RM		411 G3 3 × LARC AMF additional options available		1011 SAT 4 × Planar ARC, additional options available	
	Option	Cathodes	Cathodes		Option	Cathodes	Option	Cathodes
1 TiN		-, Ti			ECO	Ti, -, -		Ti, -, Ti, -
2 TiN-AB		TiAg, Ti			ECO	Ti, -, TiAg		Ti, TiAg, Ti, -
3 TiCN	TiCN	-, Ti			ECO	Ti, -, -		Ti, -, Ti, -
4 TiAlN		Al, Ti			ECO	Ti, Al, -		Ti, AlTi40, TiAl50, AlTi40
5 TiAlCN					ECO	Ti, Al, -		
6 AlTiN		Al, Ti	AlTi40, -		ECO	Ti, Al, -		Ti, AlTi40, -, AlTi40
7 CrN		-, Cr			ECO	Cr, -, -		Cr, -, Cr, -
8 TapCT					SCIL/FMS	LGD, -, -, CrTi50 SCIL		
9 ZrN		Zr, Ti			ECO	Ti, -, Zr		Ti, Zr, Ti, Zr
10 Omnis		Al, Cr	AlCr35, Cr		ECO	AlCr35, Cr, AlCr35		Cr, AlCr36, AlCr36, AlCr36
					SCIL/FMS	LGD, -, -, AlCr35 FMS		
					LACS	-, -, Cr, AlCr35 FMS		
11 Omnis-BX					ECO	AlCrB20_10, Cr, AlCr35		Cr, AlCrB30_10, AlCr36, AlCrSi30_10
12 AlTiCrN					ECO	Ti, Al, Cr		Cr, AlTi40, AlCr36, AlTi40
13 TiAlloy-X		AlCr35, TiSi20	AlCr35, TiSi20		ECO	Cr, Al, TiSi20		
14 nACo		AlTi33, TiSi20	AlTi40, TiSi20		ECO	Ti, AlSi18, -		TiSi20, AlTi40, TiSi25, AlTi40
15 nACRo		AlSi12, Cr			ECO	Ti, AlSi18, Cr		
16 TiXCo3		AlTi33, TiSi20			ECO	Ti, Al, TiSi20		
17 PSiX			AlTi40, TiSi20		ECO	Ti, Al, TiSi20		TiSi20, AlTi40, TiSi25, AlTi40
					LACS	Ti, Al, TiSi20, AlTi40 FMS		
18 Ti-BX					SCIL/FMS	LGD, -, -, TiB2 SCiL		
					LACS	-, -, Cr, TiB2 SCiL		
19 WC/C: a-C:H:W					SCIL/FMS	LGD, -, -, W SCIL		
20 DLC1: TiCN + a-C:H:Me	TiCN	-, Ti			ECO	Ti, -, -		
21 DLC2: CrN + a-C:H:Si					LACS & DLC	-, -, Cr, C SCiL	DLC	-, Cr, -, Cr
22 DLC2: CrN + a-C:H					LACS	-, -, Cr, C SCIL		-, Cr, -, Cr
23 DLC3: Cr + ta-C/a-C			C, Cr		LACS	-, -, Cr, C FMS		
					LACS & RM	-, Cr-RM, -, C FMS		
24 Corro-X					SCIL/FMS	Various configurations		
25 nACoX					OXI	Ti, AlSi18, AlCr45		
26 CrON-ML					OXI	-, -, Cr		

Further coatings and cathode configurations on request

Coatings for cutting tools

WORKPIECE MATERIAL		Turning	Milling			Gear cutting				Sawing	Drilling	Deep hole drilling	Reaming	Broaching	Tapping			
		Inserts	Inserts	Shank tools	Micro tools	Hobs	Pinion cutting	Skiving	Fly cutters, stick blades	Saw blades	Band saws	Drilling	Micro tools				Taps, thread cutters	Tap forming, thread forming
Steels	A	nACo	Omnis-BX	Omnis-BX	Omnis	Omnis	Omnis	Omnis	TiAlloy-X	AlTiCrN	nACo	AlTiN	nACo	AlTiN	nACo	TiN	TiN	TapCT
	B	AlTiN	AlTiCrN	AlTiCrN	nACo	Omnis-BX	Omnis-BX	Omnis-BX	AlTiCrN	AlTiN	TiAlCN	PSiX	PSiX	TiXCo3	TiXCo3	TiCN	TiCN	TiCN
Steels hardened < 55 HRC	A	TiAlloy-X	TiAlloy-X	TiAlloy-X	nACo	-	-	TiAlloy-X	-	nACo	nACo	PSiX	nACo	-	nACo	-	-	-
	B	nACo	Omnis-BX	Omnis-BX	PSiX	-	-	Omnis-BX	-	AlTiN	AlTiN	nACo	PSiX	-	TiXCo3	-	-	-
Steels hardened > 55 HRC	A	TiXCo3	TiXCo3	TiXCo3	TiXCo3	-	-	TiAlloy-X	-	-	-	TiXCo3	PSiX	-	-	-	-	-
	B	PSiX	PSiX	PSiX	PSiX	-	-	PSiX	-	-	-	PSiX	nACo	-	-	-	-	-
Stainless steel < 45 HRC	A	nACo	nACo	nACo	nACo	-	-	-	-	AlTiN	nACo	AlTiN	AlTiN	AlTiN	nACo	-	TiN	TapCT
	B	PSiX	PSiX	PSiX	PSiX	-	-	-	-	TiAlCN	TiAlCN	TiXCo3	TiXCo3	TiXCo3	TiXCo3	-	TiCN	TiCN
Stainless steel > 45 HRC	A	TiXCo3	TiXCo3	TiXCo3	PSiX	-	-	-	-	-	-	AlTiN	nACo	AlTiN	nACo	-	TiN	-
	B	TiAlCN	PSiX	PSiX	nACo	-	-	-	-	-	-	TiXCo3	PSiX	TiXCo3	TiXCo3	-	TiCN	-
Superalloys Ni-based	A	nACoX	TiAlloy-X	TiAlloy-X	Ti-BX	-	-	-	-	AlTiCrN	AlTiCrN	Ti-BX	Ti-BX	-	-	-	TiCN	-
	B	AlTiN	Ti-BX	Ti-BX	PSiX	-	-	-	-	AlTiN	AlTiN	TiAlloy-X	PSiX	-	-	-	TiAlCN	-
Superalloys Ti-based	A	nACo	TiAlloy-X	TiAlloy-X	DLC3	-	-	-	-	AlTiCrN	AlTiCrN	TiXCo3	DLC3	-	Ti-BX	-	TiCN	-
	B	Ti-BX	Ti-BX	Ti-BX	Ti-BX	-	-	-	-	AlTiN	AlTiN	AlTiN	PSiX	-	PSiX	-	TiAlCN	-
Cast iron	A	nACo	nACo	nACo	nACo	-	-	-	-	-	-	TiXCo3	-	TiN	TiXCo3	-	TiCN	-
	B	AlTiN	AlTiN	AlTiN	PSiX	-	-	-	-	-	-	nACo	-	TiCN	nACo	-	TiAlCN	-
CoCr	A			TiXCo3	TiXCo3							TiXCo3	TiXCo3					
	B			PSiX	PSiX							PSiX	PSiX					
Aluminium Si > 12%	A	nACRo	nACRo	nACRo	Omnis	-	-	-	-	nACRo	nACRo	nACRo	nACRo	-	Ti-BX	-	TiCN	-
	B	Ti-BX	Ti-BX	Ti-BX	Ti-BX	-	-	-	-	AlTiCrN	AlTiCrN	Ti-BX	Ti-BX	-	PSiX	-	TiAlCN	-
Aluminium Si < 12%	A	DLC3	DLC3	DLC3	DLC3	-	-	-	-	DLC3	ZrN	Ti-BX	Ti-BX	-	Ti-BX	-	TiCN	TiN
	B	Ti-BX	Ti-BX	Ti-BX	Ti-BX	-	-	-	-	ZrN	-	ZrN	DLC3	-	DLC3	-	Ti-BX	ZrN
Copper, bronze, brass	A	CrN	CrN	CrN	CrN	-	-	-	-	CrN	CrN	TiAlCN	-	-	TiXCo3	-	TiCN	TiN
	B	DLC2	DLC2	DLC2	DLC2	-	-	-	-	-	-	CrN	-	-	nACo	-	TiAlCN	ZrN
Plastic	A	-	-	DLC3	DLC3	-	-	-	-	-	-	TiXCo3	-	-	-	-	-	-
	B	-	-	Ti-BX	-	-	-	-	-	-	-	DLC2	-	-	-	-	-	-
Graphite	A	TiAlloy-X	TiAlloy-X	TiAlloy-X	PSiX	-	-	-	-	-	-	TiAlloy-X	TiAlloy-X	-	-	-	-	-
	B	DLC3	DLC3	DLC3	DLC3	-	-	-	-	-	-	DLC3	DLC3	-	-	-	-	-
CFRP	A	-	-	DLC3	DLC3	-	-	-	-	DLC3	-	DLC3	DLC3	-	-	-	-	-
	B	-	-	TiAlloy-X	PSiX	-	-	-	-	-	-	TiXCo3	TiXCo3	-	-	-	-	-
Wood	A	-	DLC2	DLC2	-	-	-	-	-	DLC2	-	DLC2	-	-	-	-	-	-
	B	-	CrN	CrN	-	-	-	-	-	CrN	-	TiXCo3	-	-	-	-	-	-

A primary recommendation
B secondary recommendation

Coating recommendation considers dry, wet and MQL cutting

Coatings for chipless forming

TOOL MATERIAL		Fine-blanking	Punching	Injection molding		Forming, embossing	Deep drawing	Extrusion
				Plastic	Aluminum			
HSS	A	Omnis-BX	Omnis-BX	-	-	CrN	Omnis	nACRo
	B	Omnis	Omnis	-	-	Ti-BX	Omnis-BX	Omnis
Carbide	A	Omnis-BX	Omnis-BX	-	-	-	-	-
	B	Omnis	Omnis	-	-	-	-	-
Steels unalloyed	A	-	-	CrN	AlTiCrN	-	-	-
	B	-	-	TiN	nACRo	-	-	-
Steels hardened	A	Omnis-BX	Omnis-BX	CrN	AlTiCrN	CrN	Omnis	nACRo
	B	Omnis	Omnis	TiN	nACRo	Ti-BX	Omnis-BX	Omnis
Aluminum Si > 12%	A	-	-	CrN	-	CrN	-	-
	B	-	-	TiN	-	Ti-BX	-	-
Aluminum Si < 12%	A	-	-	-	-	CrN	-	-
	B	-	-	-	-	Ti-BX	-	-
Copper, bronze, brass	A	-	-	-	-	CrN	-	-
	B	-	-	-	-	Ti-BX	-	-

A primary recommendation
B secondary recommendation

Coatings for components

WORKPIECE MATERIAL		Machine parts ¹	Medical components ²		Tribology	Decorative materials	Corrosion protection
			Surgical, dental instruments	Anti-bacterial medical components			
Steels unalloyed	A	-	-	TiN-AB	DLC2	-	Corro-X
	B	-	-	-	DLC3	-	CrON-ML
Steels hardened	A	TapCT	-	TiN-AB	DLC2	-	Corro-X
	B	-	-	-	DLC3	-	CrON-ML
Stainless steel < 45 HRC	A	-	-	TiN-AB	DLC2	Custom	Corro-X
	B	-	-	-	DLC3	-	CrON-ML
Stainless steel > 45 HRC	A	-	-	TiN-AB	DLC2	Custom	Corro-X
	B	-	-	-	DLC3	-	CrON-ML
Superalloys Ni-based	A	-	-	TiN-AB	DLC2	-	Corro-X CrON-ML
Superalloys Ti-based	A	-	DLC3	TiN-AB	DLC2	-	Corro-X
	B	-	DLC2	-	-	-	CrON-ML
Cast iron	A	CrN	-	TiN-AB	-	-	Corro-X CrON-ML
Aluminum Si < 12%	A	CrN	-	-	-	-	-
Copper, bronze, brass	A	-	-	TiN-AB	-	Custom	Corro-X
	B	-	-	-	-	-	-

A primary recommendation
B secondary recommendation

¹in abrasive and corrosive environment such as gears, water pumps, tool holders

²following PLATIT coatings are tested for biocompatibility and certified accordingly: AlTiN, CrN, DLC, TiCN, TiN, TiN-AB, ZrN

Coating properties

		Color	Nano-hardness [GPa] by Fisher Nanoindenter	Typical coating thickness [μm]	Coefficient of friction [μ] PoD (at RT, 50% humidity)	Max. service temperature [°C]
1	TiN	Gold	24–26	1–10	0.4	600
2	TiN-AB	Gold	24–26	1–3	0.4	600
3	TiCN	Grey	36–38	1–3	0.25	450
4	TiAlN	Violet grey	36–38	1–5	0.5	800
5	TiAlCN	Red violet	34–36	1–5	0.25	450
6	AlTiN	Blue grey	36–38	1–5	0.6	900
7	CrN	Silver	21–23	1–10	0.5	700
8	TapCT	Silver / Grey	28–30	1–5	0.4	700
9	ZrN	White gold	21–23	1–3	0.4	550
10	Omnis	Grey	33–35	1–5	0.5	1,100
11	Omnis-BX	Grey	36–38	1–5	0.5	1,100
12	AlTiCrN	Grey	34–36	1–5	0.5	900
13	TiAlloy-X	Grey / Copper	40–42	1–4	0.4	1,100
14	nACo	Blue violet	39–41	1–4	0.4	1,100
15	nACRo	Grey	39–41	1–4	0.5	1,100
16	TiXCo3	Copper	42–44	1–4	0.4	1,100
17	PSiX	Red brown	42–44	1–4	0.4	1,100
18	Ti-BX	Satin silver	36–38	1–4	0.4	600
19	WC/C: a-C:H:W	Dark grey	14–16	1–3	0.1–0.2	300
20	DLC1: a-C:H:Me	Anthracite	20	1–3	0.1–0.2	400
21	DLC2: a-C:H:Si	Anthracite	> 25	1–3	0.1–0.2	450
22	DLC2: a-C:H	Anthracite	> 25	1–3	0.1–0.2	400
23	DLC3: ta-C/a-C	From rainbow to anthracite	45–50	0.3–1	0.1	500
24	Corro-X	Silver	21–23	2–4	0.5	450
25	nACoX	Dark grey	30–32	4–10	0.5	>1,100
26	CrON-ML	Rainbow	24–26	2–10	0.5	600

If a coating can be deposited with ARC, SPUTTER (SCIL, FMS, TRM) and LACS option, the properties of the ARC option are given. The given physical values may vary for different coating structures.

Signature and Dedicated Coatings

PLATIT's Signature Coatings are exclusively developed by our R&D teams using the unique features of the PLATIT technology. They combine years of experience and know-how in the field of coating development with the latest technical innovations.

Our Signature Coatings promise the highest performance for their dedicated applications in the field of cutting, forming and tribological components. PLATIT customers can differentiate themselves from competitors and stand out from the market standard with the deposition of Signature Coatings.

Dedicated Coatings

Dedicated Coatings from PLATIT are tailored to individual needs of specific application and developed together with the customer for the customer. True to the open-source approach of PLATIT, the processes and recipes are open to engineers to enable innovations to accelerate.

Our Dedicated Coatings allow a variety of process parameters, configurations of the cathodes, their positions, deposition technology as well as pre- and post-treatments, depending on the adaption needs. These coatings are not limited to a certain application, going further from the field of cutting, forming and tribological components towards further industries and requirements.

Development of new Dedicated Coatings

PLATIT's R&D team inspects the geometry of the tool and considers different parameters for the development of Dedicated Coatings.

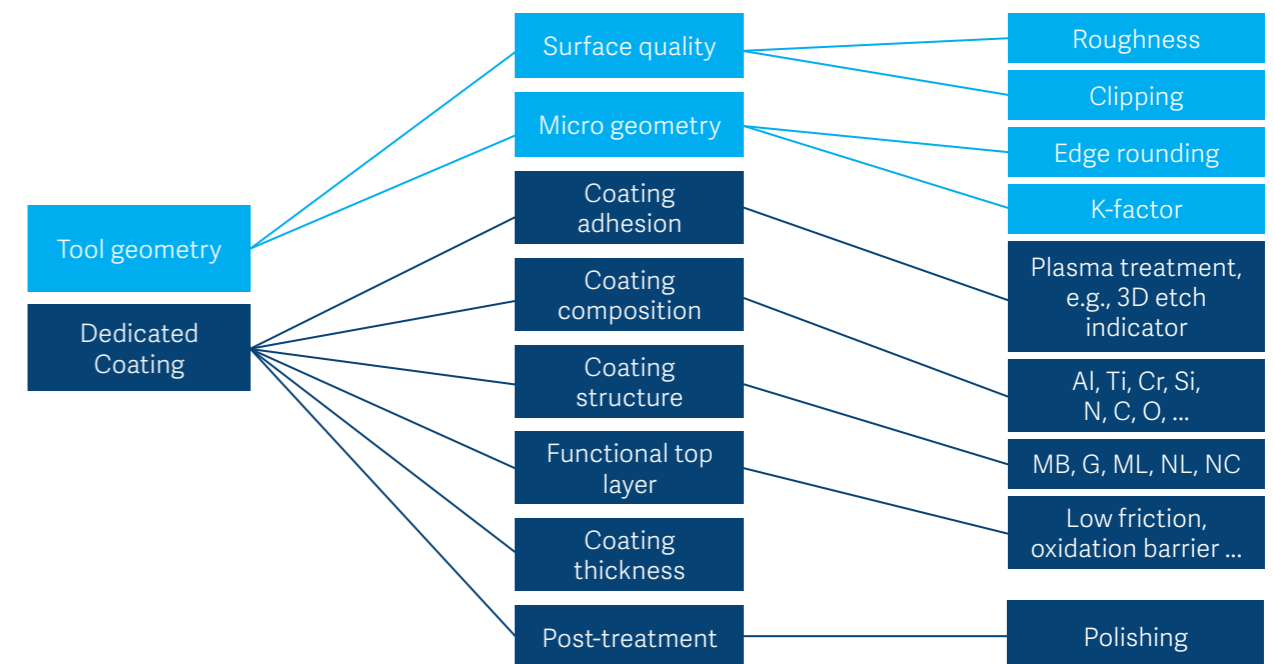

Signature Coating TiXCo3

Super-hard machining coating

As our hardest nanocomposite, TiXCo3 is especially suitable for hard machining. It can be used at very high temperatures and is therefore suitable for finishing processes in milling, drilling and reaming.

Highlights:

- High surface quality
- Extremely hard and very wear-resistant
- For super-hard machining



Specifications

Color	copper
Nano-hardness [GPa]	42–44
Coefficient of friction [μ] PoD (at RT, 50% humidity)	0.4
Coating thickness [μm]	1–4
Max. service temperature [°C]	1,100
Coating temperature [°C]	450–500
111 G3	AlTi33, TiSi20
411 G3	Ti, Al, TiSi20

Characteristics in cutting:

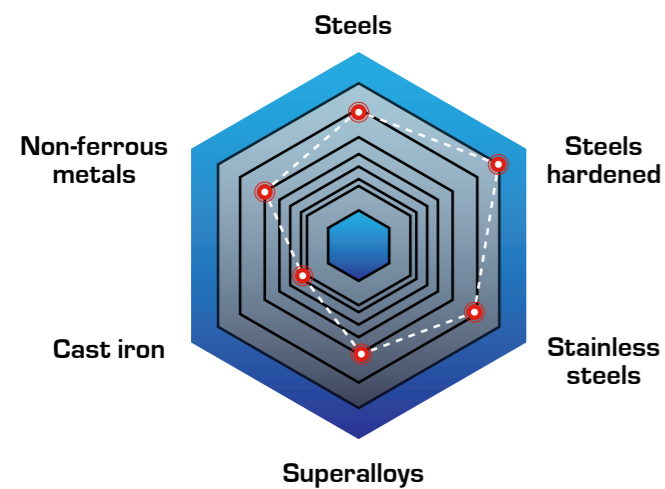

Milling in X155CrVMo with end mill:

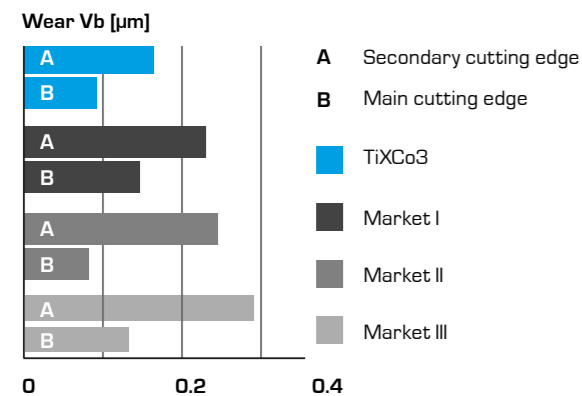

Tool: end mill; Ø0.5 z2
 Workpiece material: 1.2379 / 60-62 HRC X155CrVMo12-1 D2 / SKD11
 Cooling: dry air, 5 bar; ap = 0.09 mm; ae = 0.06 mm;
 n = 16 820 rpm; f = 0.1 mm/rot
 Source: South Korean tool manufacturer



Calo: TiXCo3

Signature Coating PSiX

Universal hard machining coating

PSiX is a PLATIT nanocomposite coating with a super-hard top layer. PSiX is based on TiXCo3 but has a silicon-free AlTiN base. Therefore, the aluminum content of PSiX is higher, which increases the coating's thermal stability. The coating is temperature optimized and therefore excellent for hard machining processes like finishing and roughing.

Highlights:

- Thermal stability
- Optimized service temperature
- Low coating residual stress

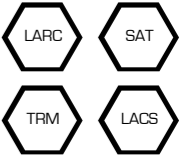

Specifications

Color	red brown
Nano-hardness [GPa]	42–44
Coefficient of friction [μ] PoD (at RT, 50% humidity)	0.4
Coating thickness [μm]	1–4
Max. service temperature [°C]	1,100
Coating temperature [°C]	450–500
111 TRM	AlTi40, TiSi20
411 G3	Ti, Al, TiSi20
411 G3 LACS	Ti, Al, TiSi20, AlTi40 FMS
1011 SAT	TiSi20, AlTi40, TiSi25, AlTi40

Characteristics in cutting:

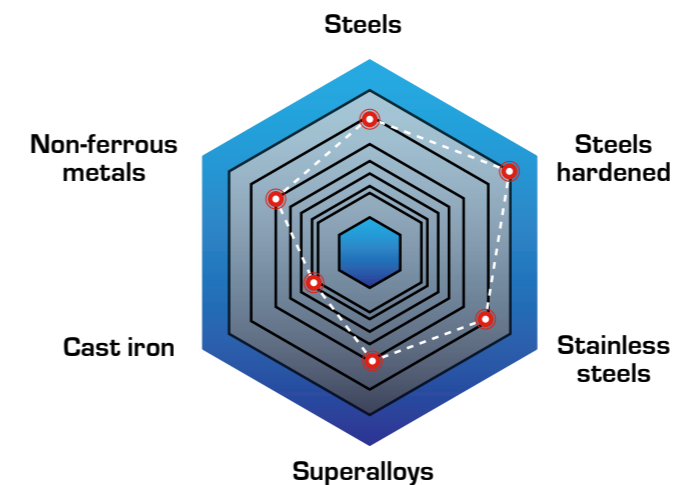

Ball nose Ø 10 2-flute

Lifetime in m at VB = 200 μm

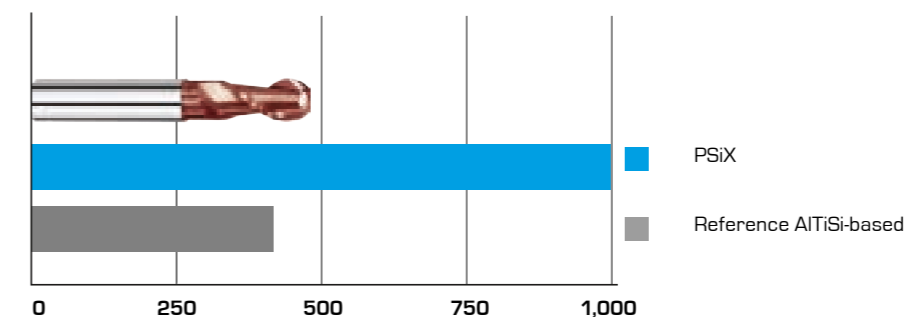

Tool: ballnose Ø 10 2-flute
 Workpiece material: 1.2379 / D2 / SKD 11 / 60-62 HRC
 Par.:vc = 240 m/min, fz = 0.14 mm/tooth,
 ap = 0.2 mm, ae = 0.5 mm down+up cut, cooling MQL external
 Source: GFE Schmalkalden, Germany

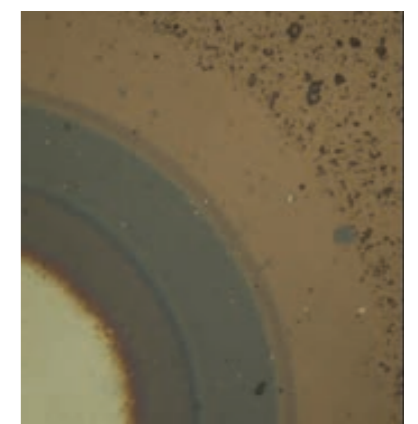

Calo: PSiX

Signature Coating nACo

Universal nanocomposite for milling and drilling C-steels

nACo is one of PLATIT's best-known coating brands. It has proven itself on the market for over 20 years. nACo is an AlTiSi-based nanocomposite coating and performs best in the field of milling and drilling C-steels. The use of nACo provides excellent adhesion and good performance even for more unusual applications such as milling with coated ceramic tools and CBN tools.

Highlights:

- Nanocomposite with Si content
- High temperature stability
- Good hardness
- Reduces adhesion between cutting edges and workpiece
- Versatile application possibilities

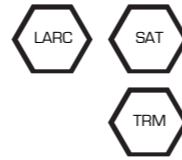

Characteristics in cutting:

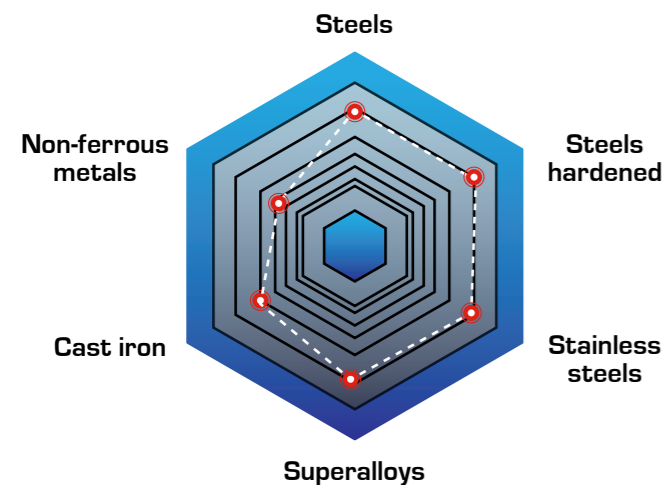

Specifications

Color	blue violet
Nano-hardness [GPa]	39–41
Coefficient of friction [μ] PoD (at RT, 50% humidity)	0.4
Coating thickness [μm]	1–4
Max. service temperature [°C]	1,100
Coating temperature [°C]	400–500
111 G3	AlTi33, TiSi20
111 TRM	AlTi40, TiSi20
411 G3	Ti, AlSi18, -
1011 SAT	TiSi20, AlTi40, TiSi25, AlTi40

Milling in SUS316 with solid carbide end mill D4:

Wear Vb [μm] after 480 milling operations

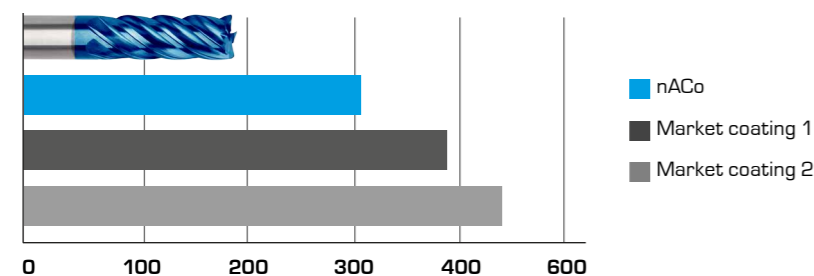

Tool: solid carbide endmill; D4; z = 4; cutting length = 6 mm
 Workpiece material: SUS316
 Coolant: ap = 0,1 mm; ae = 4 mm; vc = 100 m/min; n = 8000 U/min; fz = 0,0625 mm/z;
 f = 0,2500 mm/U; vf = 2000 mm/min
 Source: Tool Manufacturer

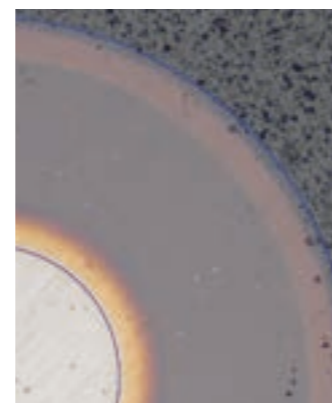

Calo: nACo

Signature Coating nACRo

Nanocomposite for non-ferrous materials

nACRo is PLATIT's nanocrystalline nanocomposite. Based on CrN adhesion layer, it has a AlCrN microcrystalline core layer for toughness and a AlCrSiN top layer which guarantees thermal stability and wear resistance. nACRo can also be deposited on sharp cutting edges for machining wood, aluminum alloy with Si content > 12% and titanium alloys such as TiAl6V4. Furthermore, nACRo can be used for aluminum injection molding.

Highlights:

- High resistance against temperature changes, oxidation and abrasive wear
- Specialist for machining abrasive aluminum alloys
- Usage also in chipless forming



Characteristics in cutting:

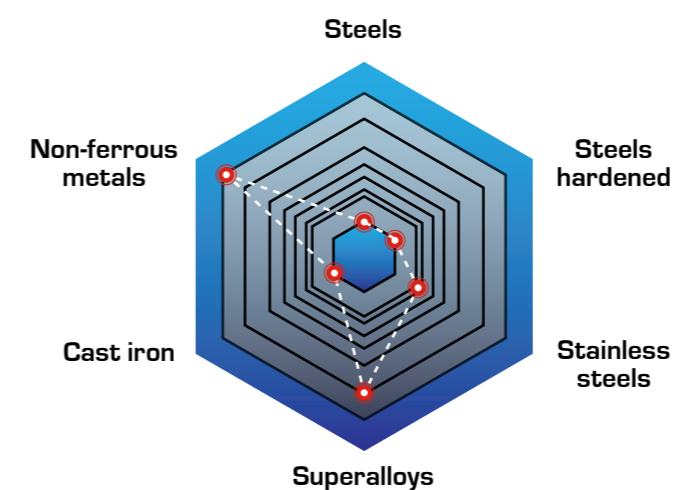

Specifications

Color	grey
Nano-hardness [GPa]	39–41
Coefficient of friction [μ] PoD (at RT, 50% humidity)	0.5
Coating thickness [μm]	1–4
Max. service temperature [°C]	1,100
Coating temperature [°C]	450–500
111 G3	AlSi12, Cr
411 G3	Ti, AlSi18, Cr

Milling in abrasive aluminum alloy:

Flank wear [μm]

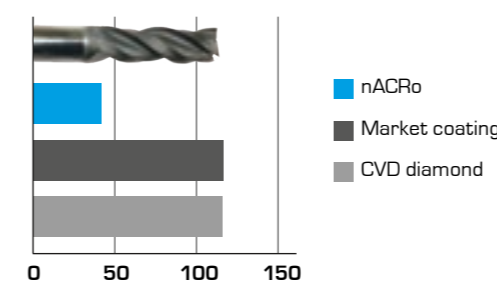

Tool: solid carbide endmill; D8; z=3; cutting length = 25 mm
 Workpiece material: EN AC 4700= <3.2583> AlSi12Cu
 Coolant: emulsion
 vc = 250 mm/min; n = rpm; ap = 5 mm; ae = 1 mm; fz = 0.16 mm/z
 Source: GFE Schmalkalden

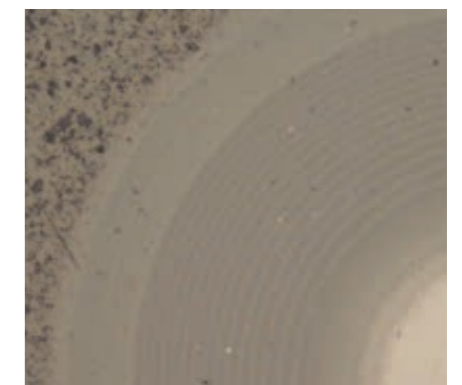

Calo: nACRo

Signature Coating Omnis

Universal high-performance AlCrN-MB coating

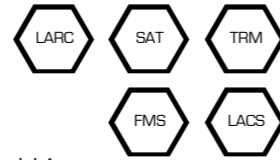

Omnis is a universal high-quality coating developed for a wide range of applications for wet and dry machining:

- Optimized coating properties (hardness, modulus, morphology) with advanced plasma parameters
- Higher productivity and deposition rate through increased process performance
- Advanced BIAS strategy for optimized residual stress distribution
- Use of multi-alloyed targets for maximum productivity

Highlights:

- Universal applicability e.g., for roughing, skiving, hobbing, finishing, forming, micro tools
- Omnis also works in applications typically covered by AlTiN and AlCrSiN coatings
- Superior and predictable wear behavior
- Fast and economical with very short batch times

Specifications

Color	grey
Nano-hardness [GPa]	33–35
Coefficient of friction [μ] PoD (at RT, 50% humidity)	0.5
Coating thickness [μm]	1–5
Max. service temperature [°C]	1,100
Coating temperature [°C]	480
111 G3	Al, Cr
111 TRM	AlCr35, Cr
411 G3	AlCr35, Cr, AlCr35
411 G3 SCIL/FMS	LGD, --, AlCr35 FMS
411 G3 LACS	-- Cr, AlCr35 FMS
1011 SAT	Cr, AlCr36, AlCr36, AlCr36

Characteristics in cutting:

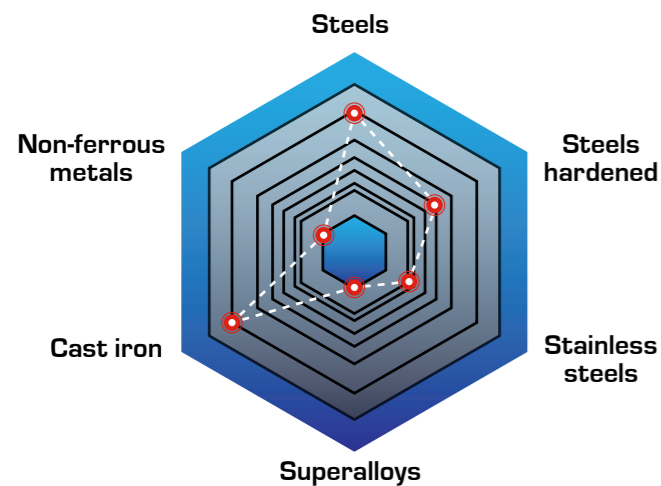

Milling in tool steel

Wear Vb [μm] after 90 m

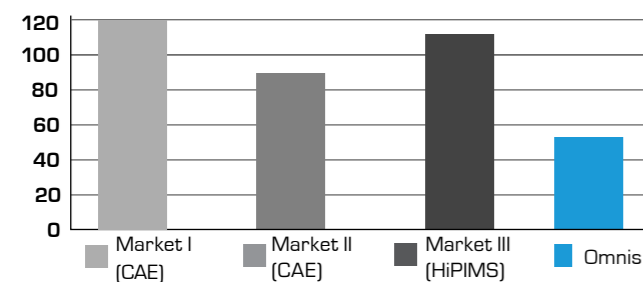

Test: side milling, passing, down-cut
Workpiece material: 1.2312 / P20 / SKT3 30-32 HRC
Tool: SC endmill, 4 flute, Ø 8
Par.: vc = 170 m/min, fz = 0.05 mm/tap = 8.0 mm, ae = 3.0 mm
Cooling: dry - air

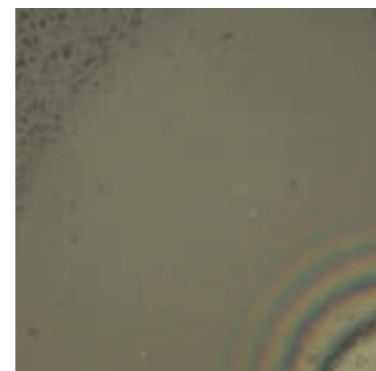

Calo: Omnis

Signature Coating Omnis-BX

Specialist for highly demanding machining



Omnis-BX consists of a boron-x doped AlCrN protective coating, which is especially suitable for crack inhibition and thus for high-speed applications such as transmission and gear cutting tools. Omnis-BX delivers top performance under high loads, especially in gear hobbing and roughing (dry and wet).

Highlights:

- Low coating residual stress
- Crack-resistant
- Minimizes crater wear
- Increases hardness and toughness

Characteristics in cutting:

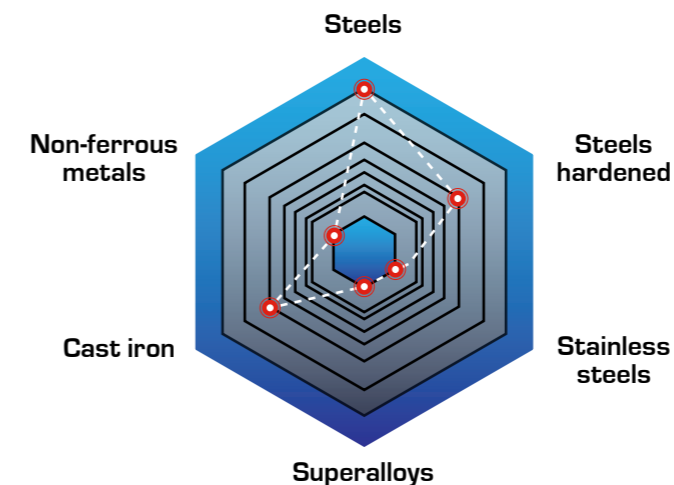

Specifications

Color	grey
Nano-hardness [GPa]	36–38
Coefficient of friction [μ] PoD (at RT, 50% humidity)	0.5
Coating thickness [μm]	1–5
Max. service temperature [°C]	1,100
Coating temperature [°C]	400–500
411 G3	AlCrB20_10, Cr, AlCr35
1011 SAT	Cr, AlCrB30_10, AlCr36, AlCrSi30_10

Effect of boron doping on crater wear in hobs:

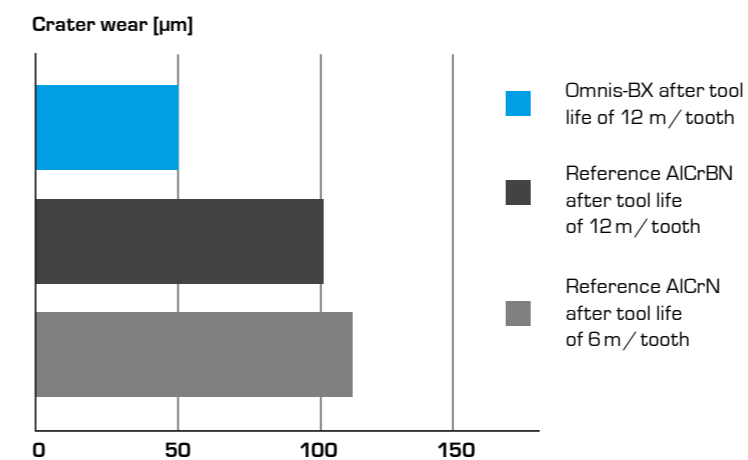

Tool: HSS hob; D100
Workpiece material: 20 MnCr 5
Cooling air; mn = 4 mm; vc = 220 m/min, fa = -6.4 mm/rot
Max. chip thickness hcu = 0.24 mm
Source: IFG Magdeburg

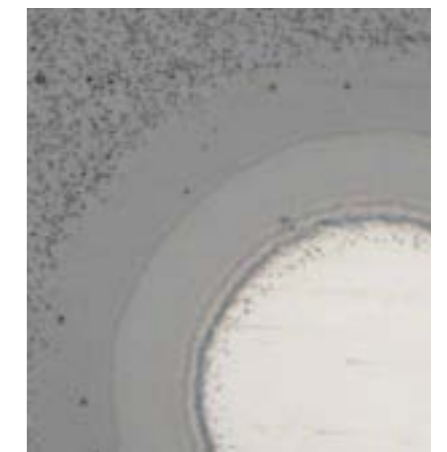

Calo: Omnis-BX

Signature Coating Ti-BX

LACS coating for aluminum & titanium alloy machining



Ti-BX summarize PLATITs specialized high-end coating solutions deposited by SCIL and hybrid LACS technology on TiB2 + X material basis. Ti-BX leaves a smooth, droplet-free surface, keeping cutting tools sharp and preventing built-up edges during operation. Ti-BX coatings perform excellent in milling, drilling and reaming of aluminum, titanium and other non-ferrous metals like copper or brass.

Highlights:

- Use for applications which favor build-up edge like Ti6Al4V (grade 5 / TC4), Inconel718 or aluminum
- Highly accurate coating for precise machining
- Increased wear-resistance

Specifications

Color	satin silver
Nano-hardness [GPa]	36–38
Coefficient of friction [μ] PoD (at RT, 50% humidity)	0.4
Coating thickness [μm]	1–4
Max. service temperature [°C]	600
Coating temperature [°C]	200–400
411 G3 SCIL/FMS	LGD, -, -, TiB2 SCIL
411 G3 LACS	-, -, Cr, TiB2 SCIL

Characteristics in cutting:

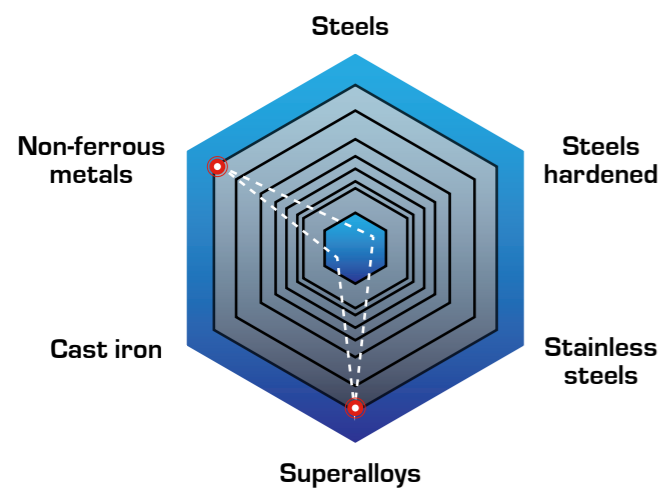

Rough milling in Ti6Al4V (TC4):

Wear Vb [μm] after 10h

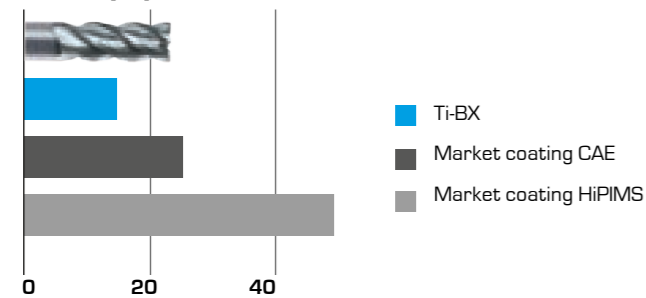

Tool: solid carbide drill Ø 5 2-flute 5xD
 Workpiece material 3.7165 / TiAl6V4 / TC4 / grade 5 ASTM B265 950 N/mm²
 Par.: vc = 60 m/min, fn = 0.098 mm/rot,
 ap = 22.5 mm, blind hole drilling, cooling emulsion
 Source: PLATIT Cutting Lab, Switzerland

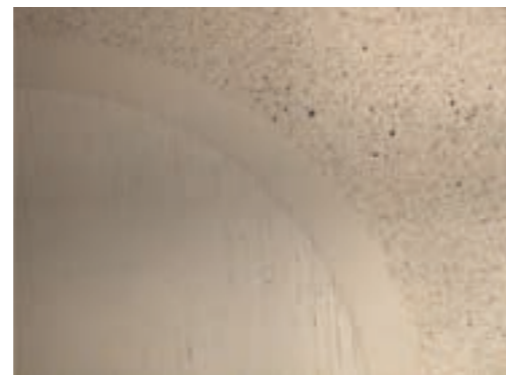

Calo: Ti-BX

Signature Coating TiAlloy-X

Number One coating for machining super alloys



TiAlloy-X coating is developed specifically for machining superalloys as TiAl6V4 or Inconel718, delivering exceptional wear resistance and thermal stability across demanding applications. Designed to withstand extreme conditions, it reduces tool wear, improves surface finish, and extends tool life. Maximize productivity and minimize downtime with our next-generation of LARC coating technology.

Highlights:

- Nanocomposite coating for extended tool life
- LARC technology enables high productivity
- High thermal stability

Variant: TiAlloy-BX

- Custom variant of TiAlloy-X with an additional BX top layer.
- Extended protection against build-up edges.
- Exclusively available with Pi411 LACS technology

Specifications

Color	grey / copper
Nano-hardness [GPa]	40–42
Coefficient of friction [μ] PoD (at RT, 50% humidity)	0.4
Coating thickness [μm]	1–4
Max. service temperature [°C]	1,100
Coating temperature [°C]	400–450
111 G3	AlCr35, TiSi20
111 TRM	AlCr35, TiSi20
411 G3	Cr, Al, TiSi20

Characteristics in cutting:

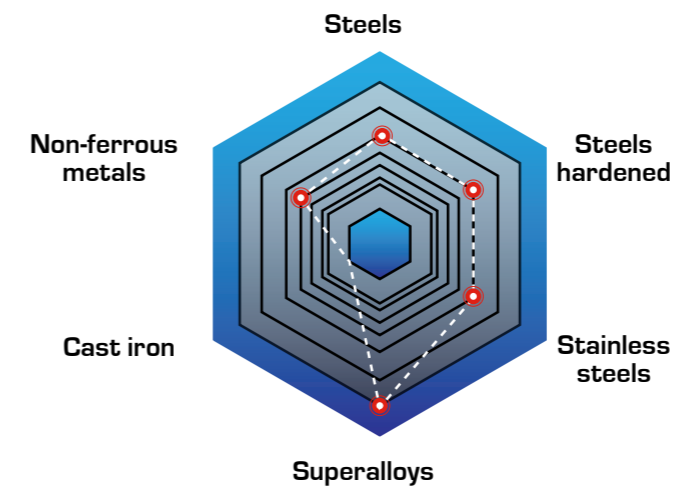

Tool life min

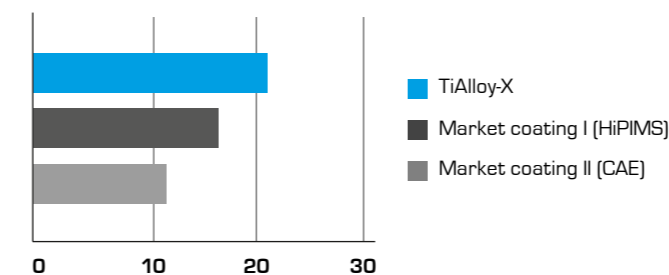

Tool: Copy Milling Cutter D50 with round insert size 10
 Workpiece material: Alloy 718 / GH4169 1.250 N/mm²
 Coolant: emulsion
 vc = 40 mm/min; fz = 0.3 mm/teeth, ap = 0.5 mm, ae = 35 mm
 Source: PLATIT Cutting Lab

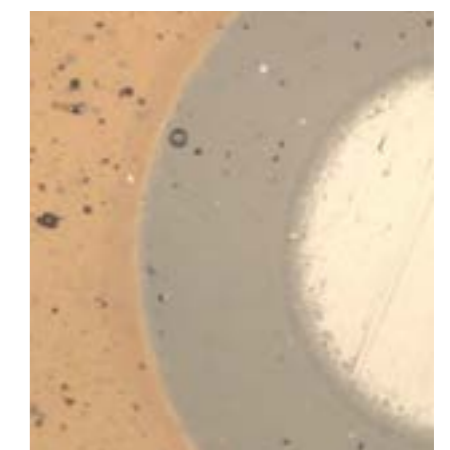

Calo: TiAlloy-X

Signature Coating ta-C

Solution for graphite machining and for non-ferrous metals

ta-C belongs to the PLATIT DLC3 hydrogen-free coating generation with over 50% sp³ content. The high sp³ bond fraction results in a higher density, hardness (at ambient and elevated temperature), thermal stability, oxidation resistance and lower thermal conductivity.

Highlights:

- Over 50% sp³ content
- High density and hardness
- Thermal stability
- Oxidation resistance
- Low chemical affinity and thermal conductivity
- Low roughness
- Stable process and low maintenance intervals

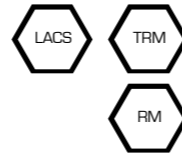

Characteristics in cutting:

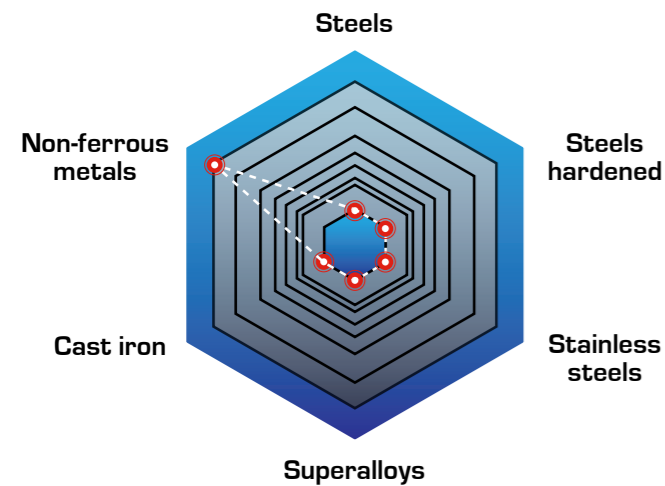

Specifications

Color	From rainbow to anthracite
Nano-hardness [GPa]	45–50
Coefficient of friction [μ] PoD (at RT, 50% humidity)	0.1
Coating thickness [μm]	0.3–1
Max. service temperature [°C]	500
Coating temperature [°C]	< 100
111 TRM	Cr, C
411 G3 LACS	-, -, Cr, C FMS
411 G3 LACS	-, Cr-RM, -, C FMS

Machining Al alloys with Si content to 10–14%:

ta-C with Pi411 G3 features higher performance and the least torque value measured

Complex Performance CP

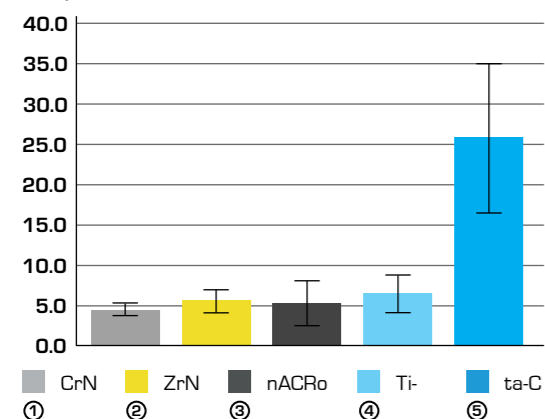

Tool: aluminum step drill; GIW/PCG
Workpiece material: GD-AISI9Cu3[Fe]; 9.3 % Si
Source: PLATIT AG and PannonPLATIT, Budapest, HU

DLC3 coated end mill under scanning electron microscope:

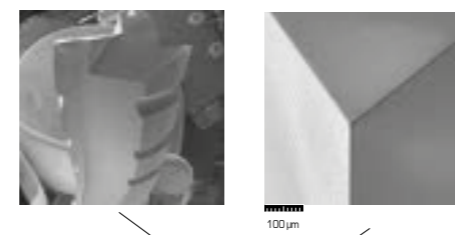

Signature Coating TapCT

SCIL coating for tap forming

TapCT is characterized by a very smooth surface thanks to the SPUTTER process SCIL® (SPUTTERED Coating Induced by Lateral Glow Discharge). Thus, during tap forming, the friction between the tool and the workpiece material and the sticking of the material will be reduced, and the process reliability increased. Furthermore, the excellent coating adhesion will increase the performance.

Highlights:

- High process reliability
- Lower machining torque
- High quality of the formed tap



Characteristics in forming:

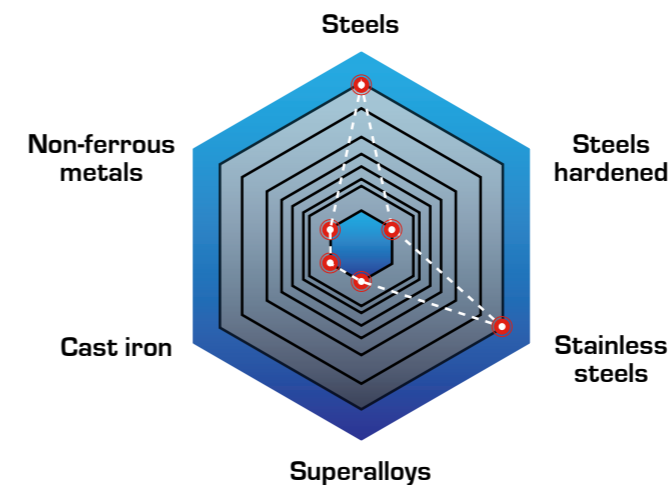

Specifications

Color	Silver / Grey
Nano-hardness [GPa]	28–30
Coefficient of friction [μ] PoD (at RT, 50% humidity)	0.4
Coating thickness [μm]	1–5
Max. service temperature [°C]	700
Coating temperature [°C]	400–450
411 G3 SCIL	LGD, -, -, CrTi50 SCIL

Tap forming in a carbon steel:

Torque after 2,000 holes [Ncm]

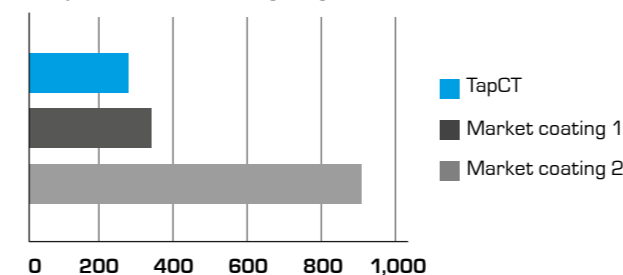

Tool: HSS forming tap M6x1
Workpiece material: carbon steel
Coolant: emulsion
vc = 20 mm/min; depth of the hole 9.0 mm
Source: Asia tool manufacturer



Calo: TapCT

Dedicated Coating example FeinAI Plus

The next generation of the dedicated coating for fineblanking applications

Longer tool life and higher tool efficiency: partner companies Blösch, Feintool and PLATIT release FeinAI Plus, a new generation of dedicated PVD coatings for fineblanking.

FeinAI set the market standard for PVD coatings of fineblanking tools over many years through its dedicated coating design and seamless integration in a process chain of customized pre- and post-treatment steps. Based on the proven concept of FeinAI and by adding several years of continuous development, the project partners announce the next level of coatings for fineblanking applications: **FeinAI Plus**

Numerous innovations lead to the unmatched tool performance of FeinAI Plus:

- Dedicated AlCr multilayer creating a tough and flexible coating structure
- Selective doping with boron, simultaneously reducing internal stress and increasing hardness
- Improved crack resistance and thus less chip welding inside the cracks
- Specialized edge rounding processes and post-polishing steps tailored to the substrate material, tool geometry, and coating design

Average wear comparison [µm]:

Average measured wear on tools from four different test series after up to 30,000 strokes

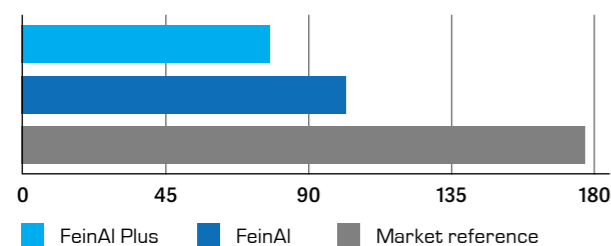

Tool: Internal forming punch; high-speed steel S390; hardness of 66 HRC
Coating thickness: 3.5 µm
Punching material: quality C60E; thickness 3 mm; tensile strength 560 MPa
Source: Feintool International Holding AG



Blösch specializes in the processing and finishing of surfaces.



Feintool is the leading manufacturer and expert in fineblanking.



PLATIT manufactures high-tech PVD and PECVD coating units for tools and components.

Specifications

Color	grey
Nano-hardness [GPa]	38–40
Coefficient of friction [µ] PoD (at RT, 50% humidity)	0.3
Coating thickness [µm]	2.0–4.0
Max. service temperature [°C]	900
Coating temperature [°C]	400–500
411 G3	Al, AlCrB20-10, Cr



CUSTOM COATING SOLUTIONS

CCS – Custom Coating Solutions

PLATIT's Custom Coating Solutions meet any special requirements. They are user-defined in every respect:

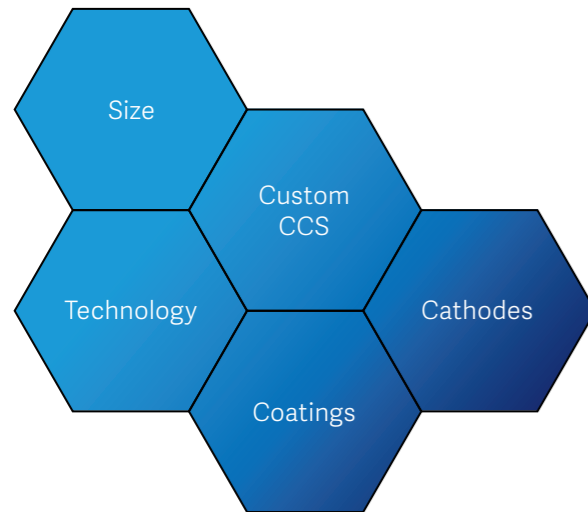

Engineers and technicians from PLATIT advise customers and design, develop, manufacture and program systems according to the individual requirements. They develop solutions in close exchange with customers and accompany them over the years by providing support and supplying spare parts.

For this purpose, PLATIT has established a network of companies for cooperation in the production of components. PLATIT also manufactures special holders as well as handling devices and works together with various partners to offer peripheral equipment adapted to the Custom Coating Solutions.

For inspiration, the following pages show different sample applications for which PLATIT has already developed, manufactured and delivered coating systems.

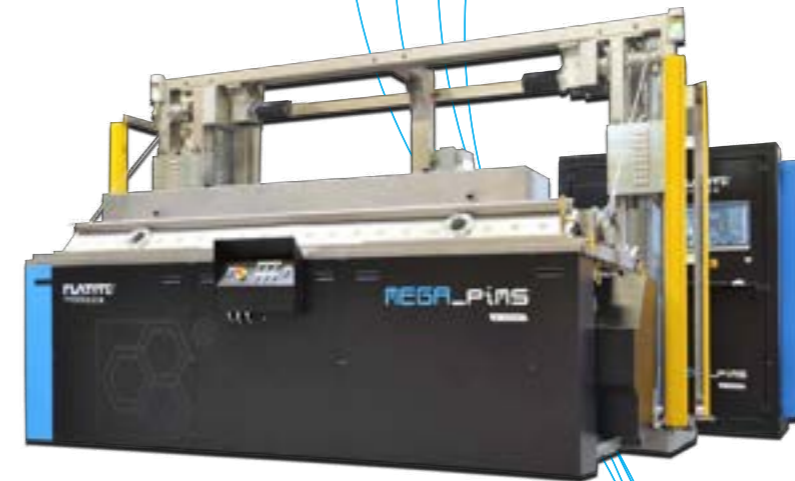
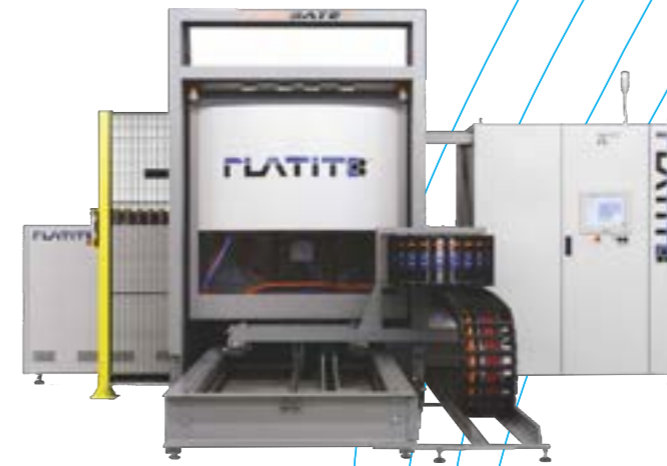

CCS for DLC (PECVD)

The PL711 is a compact HiPIMS-based SPUTTER coating solution designed for applications requiring precise, low-temperature coating processes. Equipped with two planar HiPIMS cathodes, it enables the deposition of selected nitride and carbon-based coatings (DLC2) with high plasma density and excellent coating quality.

This Custom Coating Solution is ideally suited for sensitive components where thermal load must be minimized without compromising coating performance. The PL711 delivers dense,

smooth and well-adhering coatings, making it a dedicated solution for advanced DLC and functional nitride applications beyond standard coating requirements.

Highlights

- Dense plasma with a high ionization degree in the carousel generates homogeneous coatings and reaches a high deposition rate
- Coatings from the PL711 provide outstandingly smooth surfaces with a high density, hardness and excellent adhesion.



Specifications_Sample Custom Coating Solution PL711

Technologies applied:

2 × Planar SPUTTER cathode with HiPIMS technology

Etching technologies applied:

- LGD (Lateral Glow Discharge)
- Plasma etching with argon, glow discharge
- Metal ion etching (Ti, Cr)

Deposition types:

- SPUTTER nitride coatings
 - Reactive and non-reactive processes
 - Targets: Ti, Cr
 - Coating temperature up to 350°C
- SPUTTER Cr and PECVD a-C:H:Si
 - DLC2 (PECVD)
 - Targets: Cr
 - Coating temperature: 180 - 220 [°C]

Load and cycle times:

- Max. coating volume: $\varnothing 600 \times H 805$ [mm]
- Max. coating height with defined coating thickness: 500 mm
- Max. load: 250 kg, higher weight upon request
- Max. load: 750 kg; higher weight upon request

Modular carousel systems:

- 3 or 6 or 9 axes

Software:

- Simple use and maintenance
- PLATIT SmartSoftware (PC and PLC system)
- Modern control system with touch screen
- Data recording and real-time display of process parameters and flow
- Manual and automatic process control
- Remote diagnostics and maintenance

Machine dimensions:

- Footprint: W 3,450 × D 2,250 × H 2,595 [mm]



Cathodes
2



Cycle
≥ 8.5 h



Max. Load
250 kg



Solution
Turnkey



Service
Worldwide



CCS for XL Rotating Cathodes

Coating centers and manufacturers in various applications need to be flexible in coating high volume of small and large substrates together – from high-performance cutting tools to components and forming tools. This allows them to save time and costs per batch – without compromising coating performance.

PLATIT continuously adapts coating systems and their technologies to the current and future requirements. The PVD coating units that can produce such high-performance coatings are among the best in the world and are used by very successful high-tech manufacturing companies, regrinders as well as coating centers around the world.



Sample Custom Coating Solution_Pi1511

The Pi1511 is a high-volume PVD coating unit. It combines three rotating PLATIT LARC® XL cathodes positioned inside the door with two Planar ARC cathodes in the back of the chamber. The combination of round cathodes with high-performing Planar cathodes allows for the deposition of PLATIT Signature Coatings with familiar flexibility. The LARC® XL cathodes have a very long lifespan and thus guarantee high productivity at a low cost per tool. Customers with a strong focus on innovation and technology use the mix of planar and round cathodes in the Pi1511 to generate an exceptional performance advantage with the unique cathode configuration.

Highlights:

- Uniquely flexible cathode composition with three rotating and two planar ARC cathodes for exclusive performance benefits
- Fast cathode exchange and long lifetime of the LARC® XL cathodes (Lateral Rotating XL Cathode)
- MAC-3C (Magnetic ARC Confinement – Coil Current Compensation) for automated magnetic field adjustment to increase the lifetime of a target
- Possibility to develop in-house coatings
- User-friendly and intuitive software that meets the latest standards
- Focused on specific applications in Industry 4.0

Specifications_Sample Custom Coating Solution Pi1511

Technologies applied:

- 3 × LARC® XL (Lateral Rotating XL Cathode) inside the door and 2 × Planar cathode with ARC technology in the back
- MAC-3C (Magnetic ARC Confinement – Coil Current Compensation) for automated magnetic field adjustment
- Quick cathode exchange
- Deposition of PLATIT Signature Coatings

Etching technologies applied:

- LGD® (Lateral Glow Discharge)
- Plasma etching with argon, glow discharge
- Metal ion etching (Ti, Cr)

Load and cycle times:

- Max. coating volume: \varnothing 715 × H 805 [mm]
- Max. coating height with defined coating thickness: 711 mm
- Max. load: 750 kg; higher weight upon request

Software:

- Simple use and maintenance
- PLATIT SmartSoftware (PC and PLC system)
- Modern control system with touch screen
- Statistics and help function via user interface
- Data recording and real-time display of process parameters and flow
- Manual and automatic process control
- Remote diagnostics and maintenance

Machine dimensions:

- Footprint: W 5,000 × D 2,200 × H 2,500 [mm]



Cathodes
2



Cathodes
3



Cycle
≥ 7 h



Max. Load
750 kg



Solution
Turnkey



Service
Custom



CCS for Saw Bands

The biggest challenge in the handling as well as coating of saw bands is their size as they are wound on a tool carrier, the coil. Due to circumferential speed, layer growth can result in varying coating thickness.

PLATIT has mastered this problem by developing and manufacturing a Custom Coating Solution:

- To improve the handling, the coating chamber door opens sideways; the opened chamber door can be swiveled by 90° so the loading and unloading can take place from the left-hand side
- The coil is arranged at a certain angle to the deposition technology to ensure a constant coating

thickness distribution

- The LGD® (Lateral Glow Discharge) process is used for etching and improved coating adhesion
- To guarantee a uniform coating, the teeth and the back of the saw band are coated by different cathode types
- The coating process takes place at a maximum temperature of 500 °C to ensure that the physical and chemical properties of the saw band remain unchanged
- Coating increases the lifespan of saw bands and improves the cutting performance during sawing; the development of tool wear is reduced

Sample Custom Coating Solution_Pi603

To meet the specific product requirements, PLATIT has developed a state-of-the-art turnkey system featuring a high-vacuum custom coating solution and a single-chamber cleaning system. The saw bands are wound as a coil and are both cleaned and coated with the same product carrier, ensuring an efficient and seamless process.

In 2024, PLATIT successfully implemented this advanced system for a long-standing customer, integrating the latest technology to achieve high efficiency and performance. The newly developed process enables fast coating times while maintaining excellent quality and ease of operation. Even operators who are not experienced with such

technologies can work with this unit with ease. Pursuant to the open-source principle, PLATIT has transferred its knowledge to the customer so that they can benefit from the advantages of LARC® cathodes and flexibly combine as well as develop their own coatings.

This innovation underscores PLATIT's commitment to delivering cutting-edge solutions that enhance productivity and flexibility in industrial coating applications.

Specifications_Sample Custom Coating Solution Pi603

Technologies applied:

- 3 × LARC® cathode by PLATIT with ARC technology
- 1 × Planar ARC cathode for uniform coating of the backs of saw bands

Etching technologies applied:

- LGD®
- Plasma etching with argon, glow discharge
- Metal ion etching (Ti, Cr)

Load and cycle times:

- 3 batches / day with a batch time of 7 h
- Saw band diameter up to 1,360 mm
- Inner packing diameter: 560 mm
- Saw band height up to 100 mm
- Saw band weight incl. carrier up to 600 kg

Software:

- Simple use and maintenance
- PLATIT SmartSoftware (PC and PLC system)
- Modern control system with touch screen
- Data recording and real-time display of process parameters and flow
- Manual and automatic process control
- Remote diagnostics and maintenance

Machine dimensions:

- Footprint: W 5,900 × D 6,450 × H 3,100 [mm]



Cathodes
3



Cathodes
1



Cycle
7 h



Max. Load
600 kg



Solution
Turnkey



Service
Custom



CCS for Saw Blades

When it comes to coating saw blades, the biggest challenge is to find a coating unit that can efficiently coat large quantities in a single batch at a high level of quality without damaging the saw blades. Due to their high content of heat-sensitive steel, accurately controlling the process temperature is essential. If the process temperature is too high, the saw blade deforms and thus loses its cutting force.

PLATIT designs special coating units to meet these challenges:

- The PVD unit has a temperature control system for coating saw blades; the temperature is kept within a very narrow range
- The use of ARC power supplies on alloyed targets improves the deposition rate and coating distribution, ensures uniform erosion and extends the target material's lifespan
- Pulsed cathodes and improved ARC distribution produce smoother coatings
- The coating chamber is suitable for large tools and substrates
- The modular carousel design provides maximum loading flexibility



A rail system ensures that the carousel trolley is always correctly aligned with the chamber, thereby making the loading and unloading of loads of up to 1800 kg easy. The height of the custom-designed carousel trolley can be adjusted at the touch of a button.

CCS
PL2011



Sample Custom Coating Solution_PL2011

For the coating of large saw blades up to a ϕ of 1,423 mm (56"), PLATIT has built a high-capacity coating unit. A custom-designed carousel with 6 configurations allows for maximum loading flexibility while maintaining the quality of the coating. Tools with a small or large diameter or mixed loads can be coated in one batch.

The unit is equipped with two doors to provide:

- Optimal access to the chamber
- Simplified maintenance of both the machine and the cathodes
- Simplified batch management since a completed batch can be removed through one door and the next batch loaded immediately via the other door

Specifications_Sample Custom Coating Solution PL2011

Technologies applied:

- 6 x Planar ARC cathode, 4 of which pulsed with ARC power supplies

Machine dimensions:

- Footprint: W 8,000 x D 5,800 x H 2,350 [mm]

Etching technologies applied:

- LGD® (Lateral Glow Discharge) with 2 cathodes with a shutter and 2 cathodes acting as anodes
- Plasma etching with argon, glow discharge
- Metal ion etching (Ti, Cr)

Load and cycle times:

- Coating volume up to ϕ 1,400 x H 700 [mm]
- Load up to 1,800 kg

Software:

- Simple use and maintenance
- PLATIT SmartSoftware (PC and PLC system)
- Modern control system with touch screen
- Data recording and real-time display of process parameters and flow
- Manual and automatic process control
- Remote diagnostics and maintenance

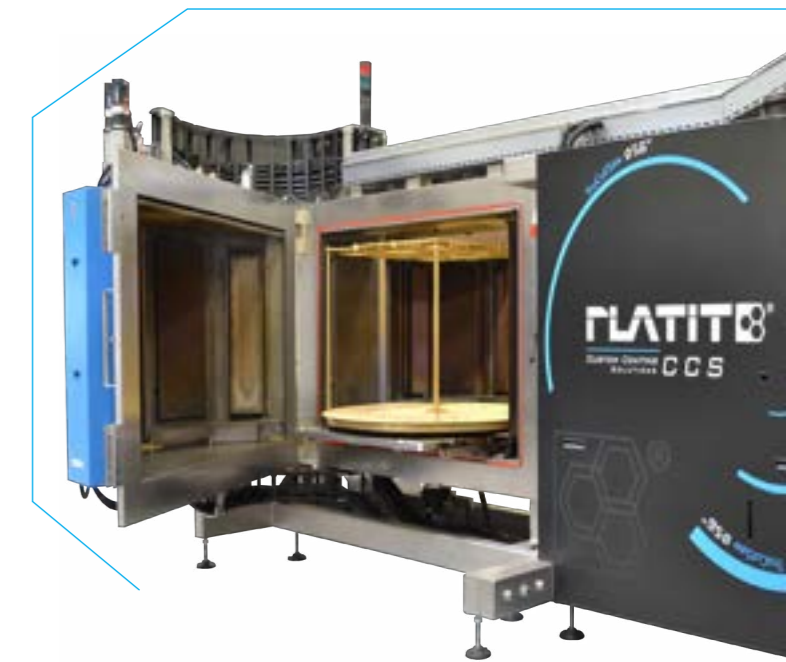

Batch times PL2011*:

Saw blade (2.5 μ m), 1fold rot.	Max ϕ 1,400 [mm]/ 56 inch	20 pcs.	8 h
Saw blade (2.5 μ m), 2fold rot.	Max ϕ 460 [mm]/ 18 inch	150 pcs.	8 h
Saw blade (2.5 μ m), 2fold rot.	Max ϕ 650 [mm]/ 25.5 inch	75 pcs.	8 h
Saw blade (2.5 μ m), 2fold rot.	Max ϕ 350 [mm]/ 13.7 inch	200 pcs.	8 h
Saw blade (2.5 μ m), 2fold rot.	Max ϕ 250 [mm]/ 9.8 inch	250 pcs.	8 h
Band saw 1.6 mm / 0.06 inch (5 μ m), 1fold rot.	5 x Coil: ϕ 400 - ϕ 680 [mm] ϕ 15.7 - ϕ 26.7 inch	320 pcs.	8 h
Shank tools (2 μ m), 4fold rot.	ϕ 8 x 70 [mm] ϕ 0.31 x 2.7 inch	3,888 pcs.	\approx 11 h
Inserts (3 μ m), 4fold rot.	ϕ 12 x 4 [mm] ϕ 0.47 x 0.15 inch	45,360 pcs.	\approx 13 h

* Average cycle times in an ongoing production with max. number of cathodes in use.



CCS for Rollers

Because of their weight, large sizes and special geometry, rollers are difficult to handle and not suitable for coating in standard coating units. The coated surface must be defect free and prevent the workpiece material sticking on the tool.

PLATIT develops Custom Coating Solutions tailored to special applications:

- The unit is set to lower system temperatures for heat-sensitive tools and machine components made of high-speed steel

- The vacuum system is further developed for steady coating thickness distribution for large chamber volumes
- Smoothest surface and micro-hardness uniformity of the coating is enabled by pulsed DC coating technology
- The design and handling concept can be flexibly adapted to the weight and size of the tools, ensuring easy operation and maximum user comfort; target change is uncomplicated

Sample Custom Coating Solution_Mega-PiMS

PLATIT has designed a Custom Coating Solution with simplified loading in which the rollers are positioned horizontally. The cathode is located at the bottom of

the coating chamber. PLATIT's SPUTTER technology is used to guarantee smooth coatings for high-gloss-polished or textured surfaces.



Specifications_Sample Custom Coating Solution Mega-PiMS

Technologies applied:

- 1 x SPUTTER cathode
- 1 x anode on the opposite side

Etching technologies applied:

- LGD® (Lateral Glow Discharge)
- Plasma etching with argon, glow discharge

Load:

- Coating volume up to $\varnothing 600 \times L 3,000$ [mm]
- Coating volume with defined coating thickness up to $\varnothing 600 \times L 2,000$ [mm]
- Load up to 1,000 kg; higher weight upon request

Software:

- Simple use and maintenance
- PLATIT SmartSoftware (PC and PLC system)
- Modern control system with touch screen
- Statistics and help function via user interface
- Data recording and real-time display of process parameters and flow
- Manual and automatic process control
- Remote diagnostics and maintenance

Machine dimensions:

- Footprint (coating unit with electrical cabinet):
W 4,100 x D 2,900 x H 2,700 +
W 1,900 x D 1,100 x H 2,200 [mm]

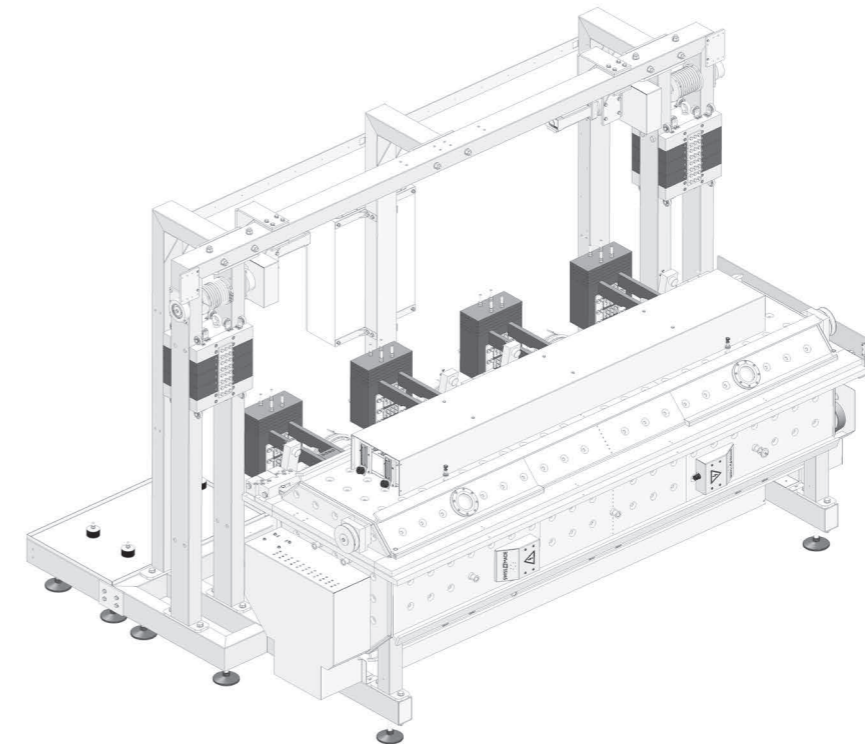

Cathodes 1	Max. Load 1,000 kg	Solution Turnkey	Service Custom

CCS for Coin Minting Dies

Custom Coating Solution for Coin Minting Dies

When coating stamps, punches and coin minting dies, ensuring surface quality is essential. These surfaces require smooth, dust-free coatings with excellent adhesion to accurately replicate highly detailed relief structures. The requirements increase when minting dies are used for proof coins, where temperature-sensitive materials are often involved. They have narrow tolerances and can only be coated within a certain temperature range.

For coin minting dies, PLATIT has developed a Custom Coating Solution for high-quality coatings with a strong amorphous structure, high density, surface quality and reproduction accuracy.

Highlights:

- Designed to meet for the highest demands the surface of proof coins
- Full temperature control for temperature-sensitive substrates
- Specific holders developed for various stamp sizes and geometries or customized upon request
- Guaranteed smooth dust-free coatings, since the surface to be coated faces downwards; the target is placed on the bottom of the coating chamber
- SPUTTER technology from PLATIT, supported by LGD® (Lateral Glow Discharge) ensures very good adhesion; thus, there are no droplets and no layer defects



Specifications_Sample Custom Coating Solution S-MPuls

Technologies applied:

- 1 × DC-pulsed magnetron SPUTTER cathode with a rotating magnetic field
- SPUTTER source arranged at the bottom of the chamber

Etching technologies applied:

- LGD®
- Plasma etching with argon, glow discharge, with auxiliary anode

Load and cycle times:

- Batch time of 3–4.5 h
- Coating diameter with defined coating thickness: \varnothing 70–250 [mm]
- Substrate holder: \varnothing 300 mm, varying customer-specific versions possible
- Load up to 20 kg

Software:

- Simple use and maintenance
- PLATIT SmartSoftware (PC and PLC system)
- Modern control system with touch screen
- Statistics and help function via user interface
- Data recording and real-time display of process parameters and flow
- Manual and automatic process control
- Remote diagnostics and maintenance

Machine dimensions:

- Footprint (coating unit with electrical cabinet):
W 945 × D 1,403 × H 2,068 +
W 608 × D 1,369 × H 2,068 [mm]



CCS
S-MPuls



Cathodes
1



Cycle
≥ 3 h



Max. Load
20 kg



Solution
Turnkey



Service
Custom



Ceramicoin

Dedicated PVD coating for Coin Minting Dies

Ceramicoin, deposited with S-MPuls, replicates every detail of the surface and is thus a significant advantage for coin appearance and design features.

Quality features of Ceramicoin:

- Surface quality
- Durability
- Smoothness
- Coating adhesion
- Replication of every detail
- Extended die life

Advantages of PVD technology compared to Cr-plating:

- No hexavalent chromium
- No noise
- No chemicals
- No contamination
- No fumes
- No toxic waste
- No risk for your health



Residues from engraving (oxides)



Residues from polishing



Material inhomogeneities (pores or carbides)

Highlights:

- Coin minting dies ready to use
- No post-polishing needed
- No post-cleaning needed
- Fast cycle times: < 4 h
 - Pumping, heating: ~ 60 min
 - Etching: ~ 35 min
 - Coating: ~ 40 min
 - Cooling, venting: 30 – 60 min

Specifications

Color	satin silver
Nano-hardness [GPa]	32
Coefficient of friction [μ] PoD (at RT, 50% humidity)	0.4
Coating thickness [μm]	1
Max. service temperature [°C]	600
Coating temperature [°C]	200

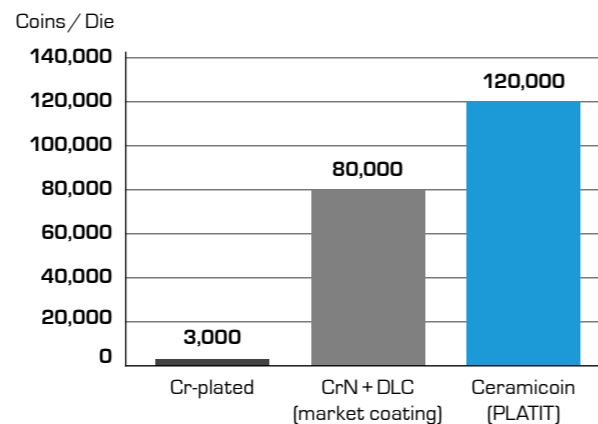

Perfect replication solution of surface structures

Phantom color process

- Uses high-energy laser beams to create extremely fine and precise surface patterns that produce light-based color effects on both the coin stamp and the final coin
- Ceramicoin's ultra-thin, smooth coating (1 μm) protects the stamp while preserving the visual effects, ensuring the colors remain intact on both surfaces

Color-replicating 3D pattern stamps:

- The color pattern from the stamp is physically transferred onto the coin's surface during the minting process
- Previously, uncoated stamps were required for this effect, but they have a short lifespan
- With Ceramicoin coating by S-MPuls, the stamps prove a boost in lifespan while still preserving the color effect on the coins

TURNKEY SOLUTIONS



The TKS concept

PLATIT's turnkey system with complete solutions for upstream and downstream steps for hard coating is ideally suited for seamless integration into the tool manufacturing and regrinding process. As a partner for its customers, PLATIT takes responsibility for the functionality of the whole system.

PLATIT provides and integrates everything needed for a successful coating center:

- Depending on the requirements, different dimensions of coating chambers for the coating of small to oversized substrates
- Comprehensive coating know-how
- Equipment for decoating high-speed steel and carbide
- Equipment for edge pre-treatment
- Vacuum-assisted single-chamber cleaning units
- Systems for easy quality control of the coating
- Equipment for post-treatment, such as polishing
- PVD production accessories from sleeves to handling systems and chillers

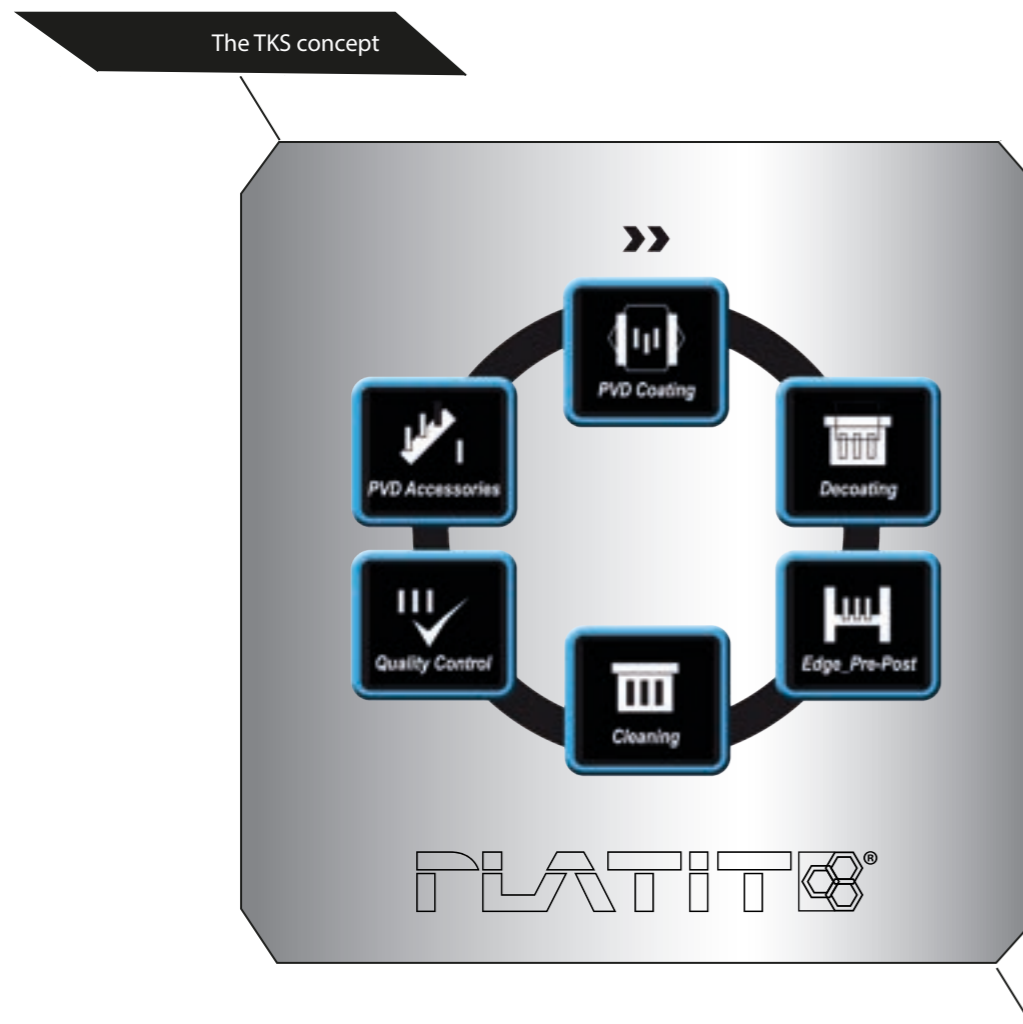

PLATIT cooperates with partner companies to offer a wide range of peripheral equipment for upstream and downstream steps of the coating process. Flexibly tailored to the various applications, PLATIT's

processes are integrated into its customers' tool manufacturing and thus guarantee an independent, stable and innovative production process.

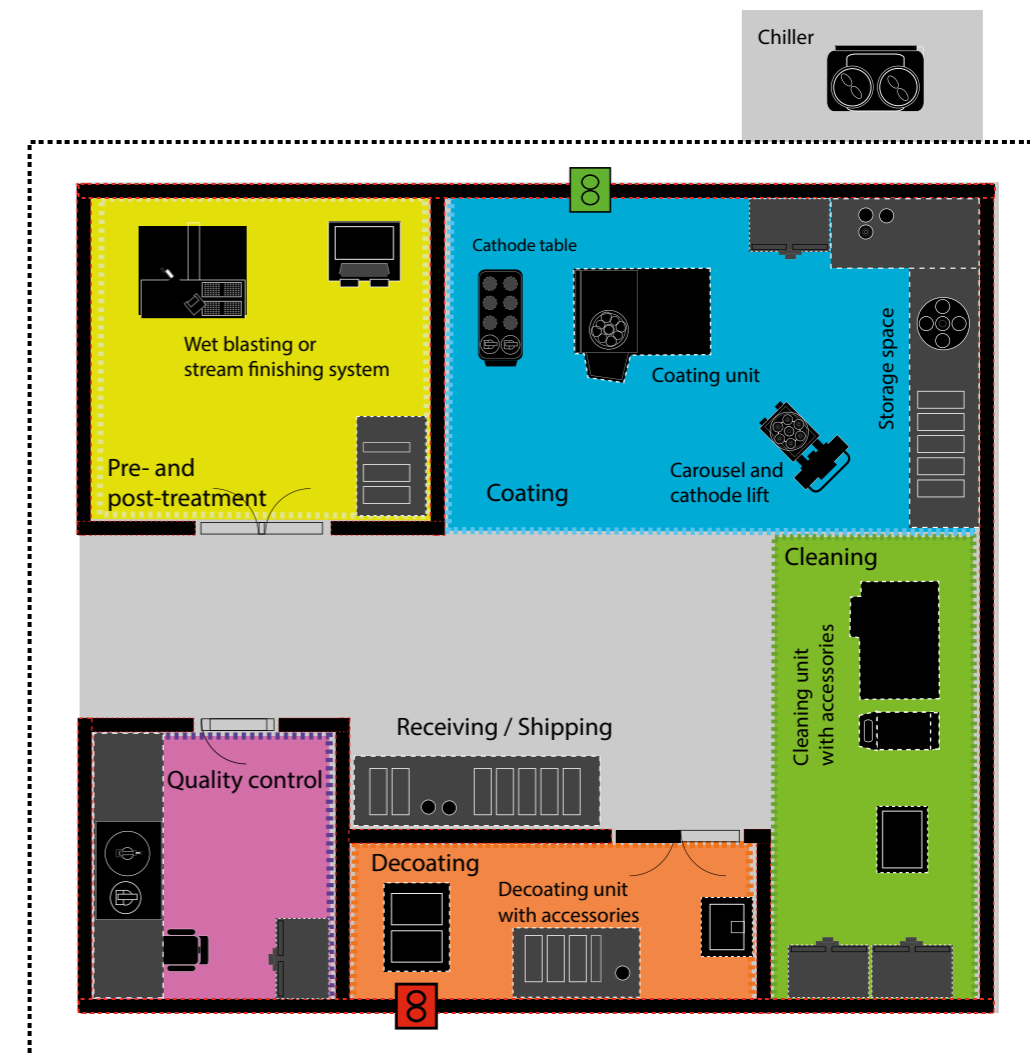

Typical workflow in a coating center with PLATIT's turnkey solutions:

1. Receipt of goods
2. Preliminary cleaning
3. Optional: decoating
4. Optional: edge pre-treatment
5. Fine-cleaning
6. Preparation for coating
7. Coating
8. Unloading of a batch
9. Optional: post-treatment
10. Quality control
11. Goods output

Some modules (decoating, pre- and post-treatment) should be set up in a separate room from the coating units. Chiller must be placed separately.

Decoating

Decoating/stripping is an important prerequisite for recoating at a high level of quality. The old, used coating is removed so that the new one will adhere

well to the reground tool and achieve a high degree of performance. Regrinding without decoating leads to a reduction of the tool's lifespan.

Conventional process

In coating centers, tools are usually decoated after regrinding. However, decoating after regrinding can damage the final geometry of the tool and increase

the risk of poor adhesion. In addition, packaging, transport and repackaging involve the risk of damaging the tool.

Integrated process

By integrating the decoating process into the tool regrinding, decoating can take place before the regrinding.

- Advantages:**
- Elimination of transport and packaging
 - Less damage caused by handling
 - Chemical destruction after regrinding is prevented
 - Edge pre-treatment is fully effective
 - Adhesion is optimized
 - The tool performs almost as well as a new one

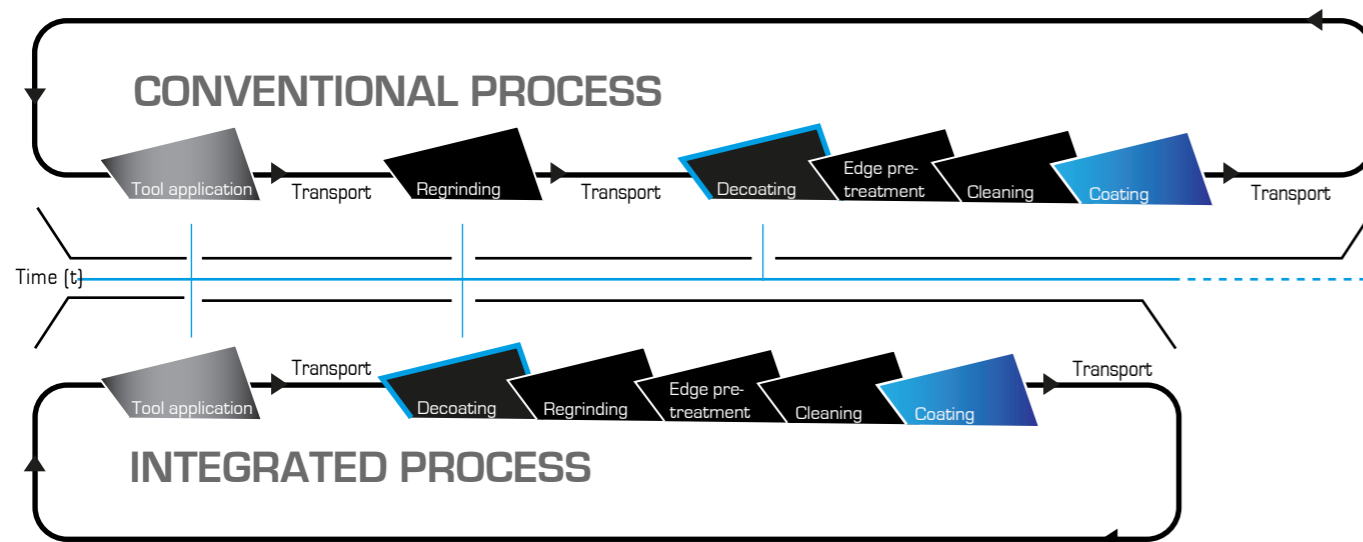

In decoating carbide, the biggest challenge is to avoid damaging the substrates. The most common damage is caused by cobalt leaching.

The coating of cobalt-leached carbide is not effective. Although the coating will adhere well to the top tungsten carbide layer, the tungsten carbide, along with the coating, will not adhere to the base material due to the lack of cobalt binder.

Cobalt leaching refers to the removal of the cobalt binder from the top layer of the carbide. The most common reasons are:

- Chemical decoating
- Aqueous cleaning
- Water-cooled grinding
- Grinding too fast with a blunt grinding wheel

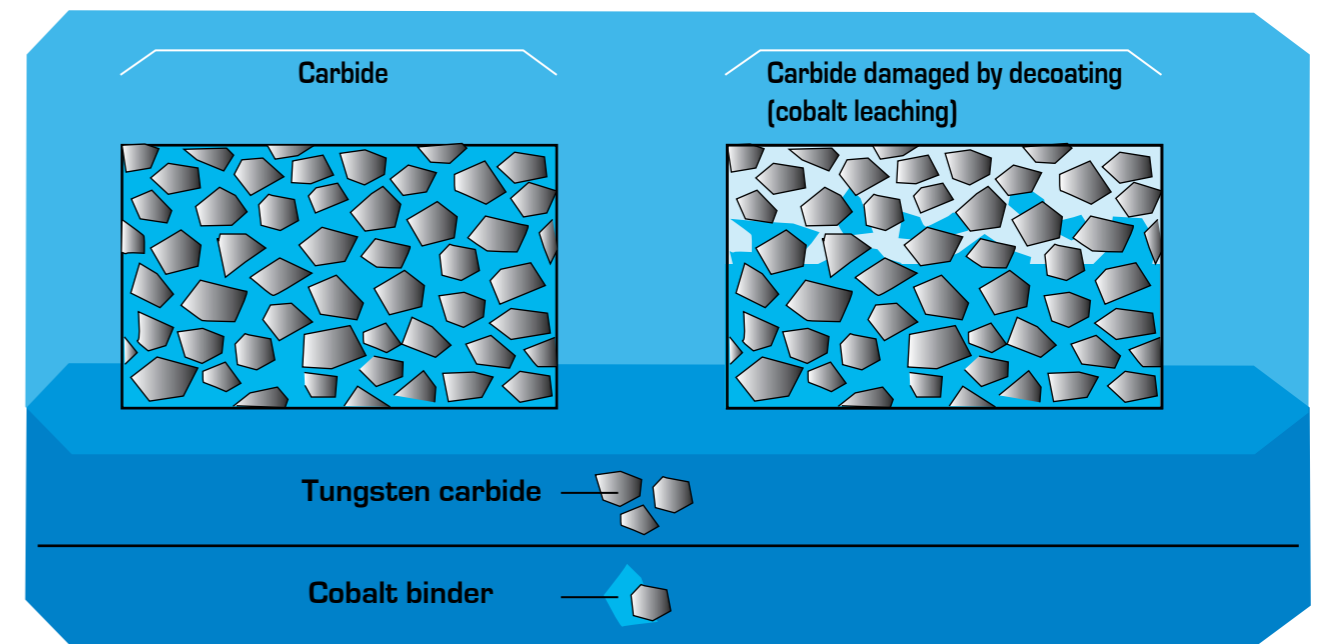

PLATIT Decoating unit concepts

PLATIT offers two types of decoating units – for carbide and high-speed steel – which can be customized according to the customer's requirements.

Decoating

PLATIT CT20 Ultra-fast decoating unit

CT decoating systems from PLATIT set new standards in decoating, especially for carbide tools. The problem of cobalt leaching is circumvented by protecting the substrate with a TiN adhesion layer as the decoating process of the CT systems will not attack the TiN layer. For the CT20, the decoating cycle all the way to the TiN adhesion layer will take less than three minutes.

The end of the process is automatically detected by built-in electronics. The adhesion layer is not removed and therefore "overcoated" after regrinding and pretreatment. A service life comparable to that of a new tool is achieved.



Features:

- The new environmentally friendly wet chemical carbide decoating unit from PLATIT
- Fastest decoating process worldwide
- Decoating time is less than 3 minutes all the way to the TiN adhesion layer and the decoating cycle stops automatically at the TiN adhesion layer
- A single recipe for a wide variety of nitride coatings with a TiN adhesion layer, independent of tool size
- Multiple coatings can be removed as well
- Special holders for shank tools, hobs, inserts etc. to avoid attacking uncoated areas
- Max. tool dimensions: $\varnothing 200 \times 250$ mm
- Common chemicals available worldwide
- The process takes place at room temperature, neither heating nor cooling is required
- The end of the process will be automatically detected, which greatly simplifies the operator's work

	111 G3	111 TRM	411 G3	711	1011 SAT	
TiN	N		N	N	N	
TiCN	N		N		N	
TiAlN	Y		Y		Y	3 min*
TiAlCN			Y		Y	3 min*
AlTiN	Y	OPT	Y		OPT	3 min*
CrN	OPT		OPT	N	OPT	2 min*
TapCT			N			
ZrN	Y		Y		Y	2 min*
Omnis	N	N	OPT		N	2 min*
Omnis-BX			N		N	
AlTiCrN			Y		N	3 min*
TiAlloy-X	N		N			
nACo	N	N	Y		N	3 min*
nACRo	N		OPT			3 min*
TiXCo3	N		Y			3 min*
PSiX		N	Y		N	3 min*
Ti-BX			N			

* Up to the TiN adhesion layer
 ⌚ Decoating time for 2 μm , $\varnothing 10$ mm
 Y = can be decoated with CT20/N = cannot be decoated with CT20
 OPT = optionally decoatable if TiN adhesion layer is applied
 Empty = no standard recipe for the coating unit available

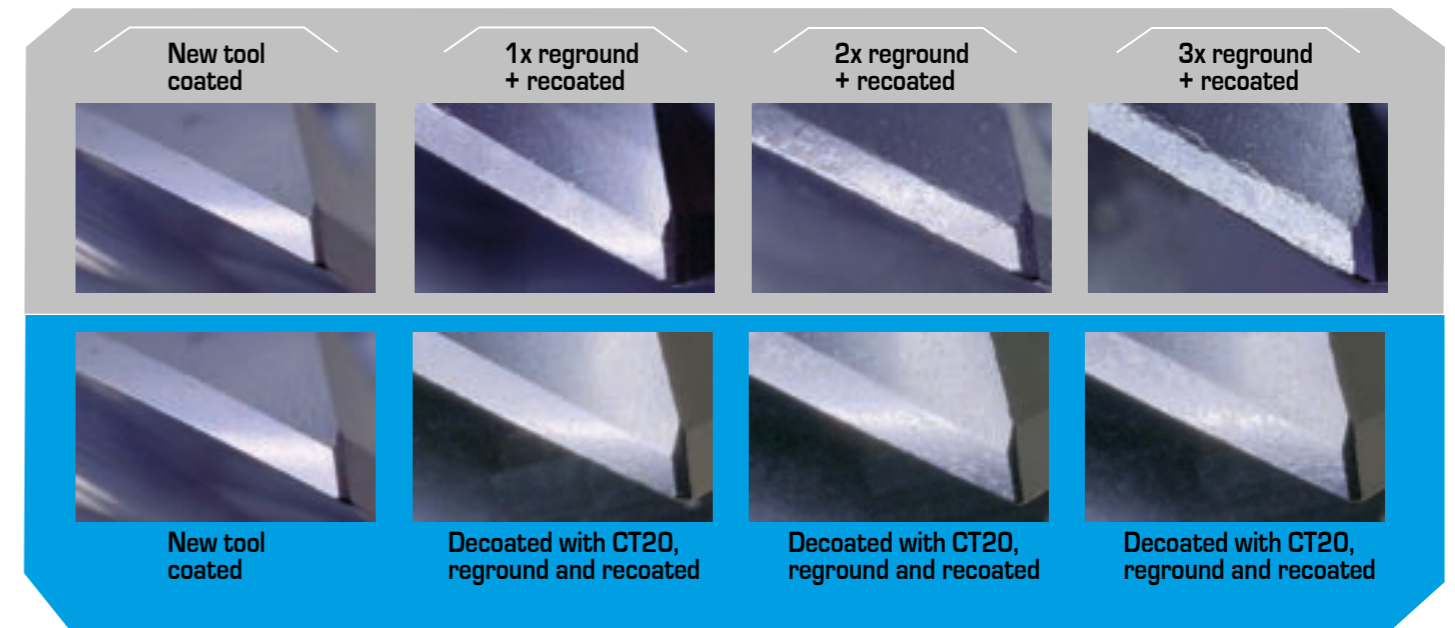

Without decoating, roughness increases and tool life decreases
 Roughness and tool life remain constant, if the tool gets decoated with PLATIT CT20 before regrinding

Decoating

PLATIT ST40_Conventional decoating units

ST decoating units from PLATIT stand for great safety and flexibility.

Depending on the module, they decoat Ti- or Cr-based coatings on carbide or high-speed steel.

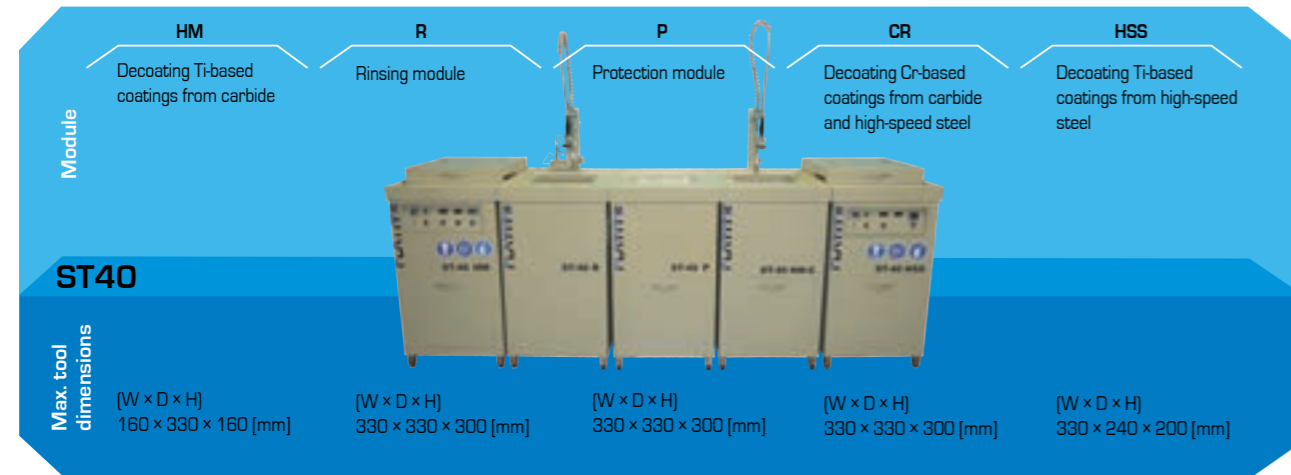

ST40_Carbide shank tools:

Coating	A1	B	C
TiN	4–5 h	T-HM	HM
TiCN	6–8 h	T-HM	HM
TiAlN	10–18 h	T-HM	HM
AlTiN	10–18 h	T-HM	HM
CrN	0.5–3 h	C	CR
TapCT	-	-	-
ZrN	-	-	-
Omnis	1–2 h	C	CR
Omnis-BX	1–2 h	C	CR
TiAlloy-X	-	-	-
nACo	9–11 h	T-HM	HM
nACRo	0.5–2 h	C	CR
TiXCo3	5–9 h	T-HM	HM
PSiX	10–18 h	T-HM	HM
Ti-BX	1–2 h	T-HM	HM

ST40_High-speed steel hobs:

Coating	A2	B	C
TiN	~ 1 h	T-HSS	HSS
TiCN	~ 2 h	T-HSS	HSS
TiAlN	1–2 h	T-HSS	HSS
AlTiN	1–2 h	T-HSS	HSS
CrN	0.5–3 h	C	CR
TapCT	-	-	-
ZrN	-	-	-
Omnis	1–2 h	C	CR
Omnis-BX	1–2 h	C	CR
TiAlloy-X	-	-	-
nACo	0.5–2 h	T-HSS	HSS
nACRo	0.5–2 h	C	CR
TiXCo3	1–3 h	T-HSS	HSS
PSiX	1–2 h	T-HSS	HSS
Ti-BX	1–2 h	T-HSS	HSS

A1 Decoating time for 2 µm, ø 10 mm

A2 Decoating time for 2 µm, ø 80 x 180 mm

B Decoating recipe*

C Module

* Different decoating chemicals available through the worldwide distribution network of Borer AG, Zuchwil, Switzerland
 - = cannot be decoated in conventional decoating units

Edge pre-treatment

The edge pre-treatment is a very important process in a turnkey system designed to utilize the full potential of a coating.

The main aim of edge pre-treatment is to increase the edge's stability and thus the tool's performance.

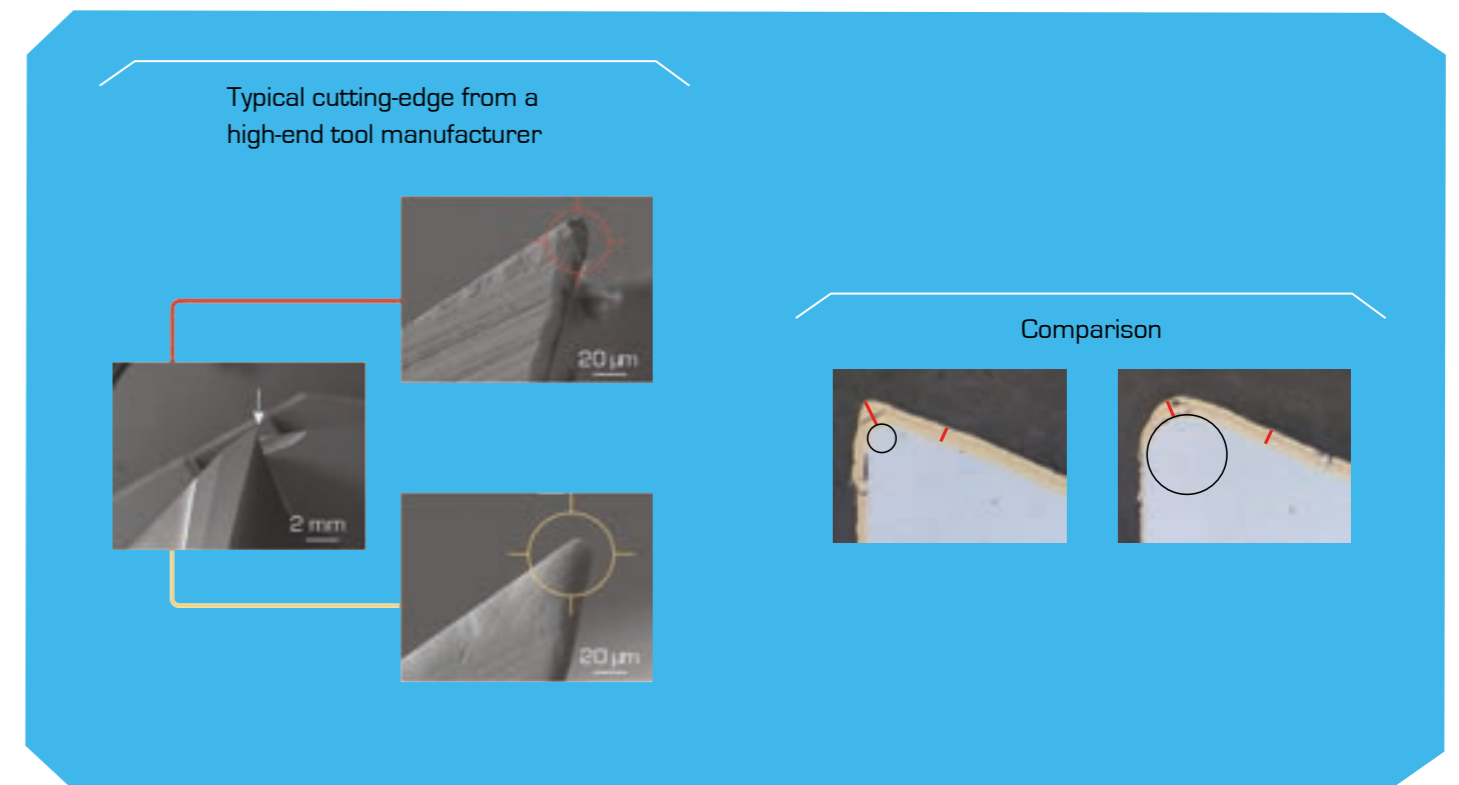

Advantages of cutting-edge rounding:

- Reduces chipping
- Reduces what is referred to as an "antenna effect" in PVD coatings on sharp edges and thus reduces the stress in the coating
- The more an edge is rounded, the thicker the coatings can be
- Higher cutting-edge stability
- Avoids cutting-edge breakouts and flaking of the coating during the machining process
- Increase of the tool's lifespan despite a "blunt" cutting-edge

Edge pre-treatment

Influence of cutting-edge rounding when milling high-alloy steel

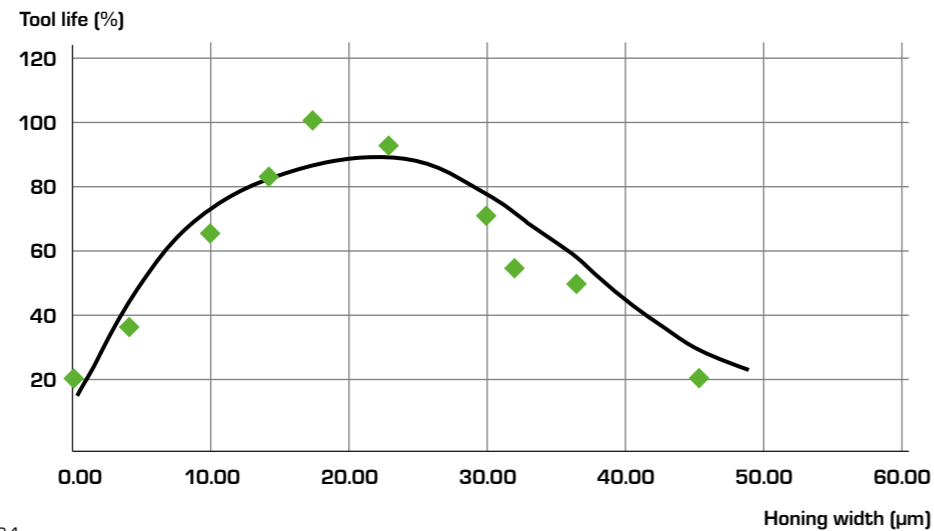

Tool: end mill, D10, z = 4
 Workpiece material: 1.2379; X155CrVMo12-1
 $a_p = 1.5 \times d$
 $a_e = 0.25 \times d$
 $v_c = 150 \text{ m/min}$
 $f_z = 0.05 \text{ mm/z}$
 Source: GFE, Germany
 Coating: nACRo

— Polynomial (Standweg)
 ◆ Standweg

Influence of cutting-edge rounding when drilling

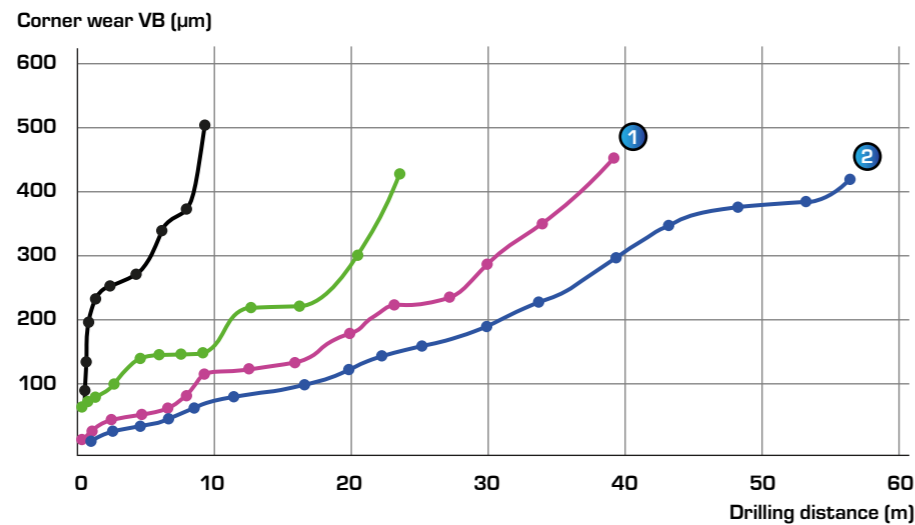
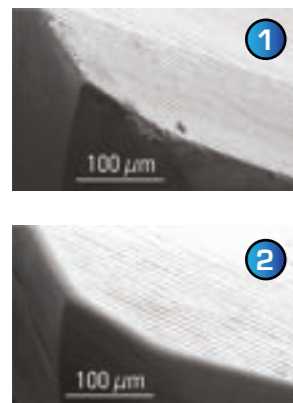

Tool: blind holes; VHM drill; D5
 Workpiece material: cold work steel; 1.2379; X155CrVMo12-1; HRC22
 Cooling: dry air
 $a_p = 15 \text{ mm}$
 $v_c = 75 \text{ m/min}$
 $f_z = 0.15 \text{ mm/z}$
 Coating: nACo

— Edge sharpened
 — Edge rounded without edge honing R = 15 µm
 — Edge with honing without rounding
 — Edge with honing and rounding R = 15 µm

Methods of edge pre-treatment

Different materials and tools require different methods of edge pre-treatment. Below is an overview of the most common ones:

Method	Dry blasting	Wet blasting	Stream finishing	Brushing	Magnet finishing
Tool type					
Drills	+	++	++	+++	+++
End mills	+	++	+++	+++	+++
Inserts	++	+++	+	++	+
Hobs	++	+++	+	+	-
Punches	+	+++	+++	-	-
Molds and dies	+++	+++	-	-	-
Characteristics					
Stability	+++	+++	+++	+++	+++
Flexibility	+++	+++	++	++	++
Productivity	+	+++	++	++	++
Groove polishing possible	Limited	Yes	Yes	Yes	Limited
Automation solutions possible	Yes	Yes	Yes	Yes	Yes
Special characteristics	Blasting media sticks to the surface	Universally usable	Smooth surface	Individual treatment for cutting-edges and surfaces possible	Especially for micro tools

+++ High quality and high efficiency
 ++ High quality or high efficiency
 + Low quality and/ or low efficiency
 - Not suitable for the system

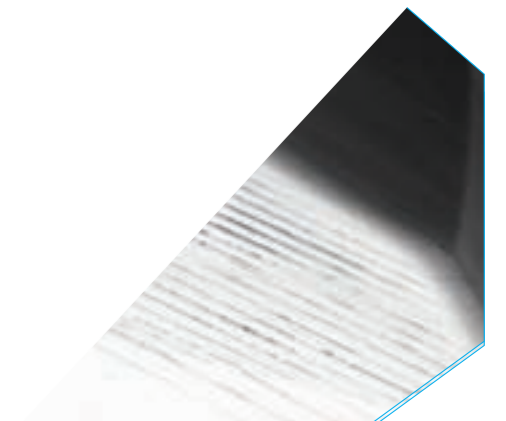

Edge pre-treatment

Comparison of wet and dry blasting

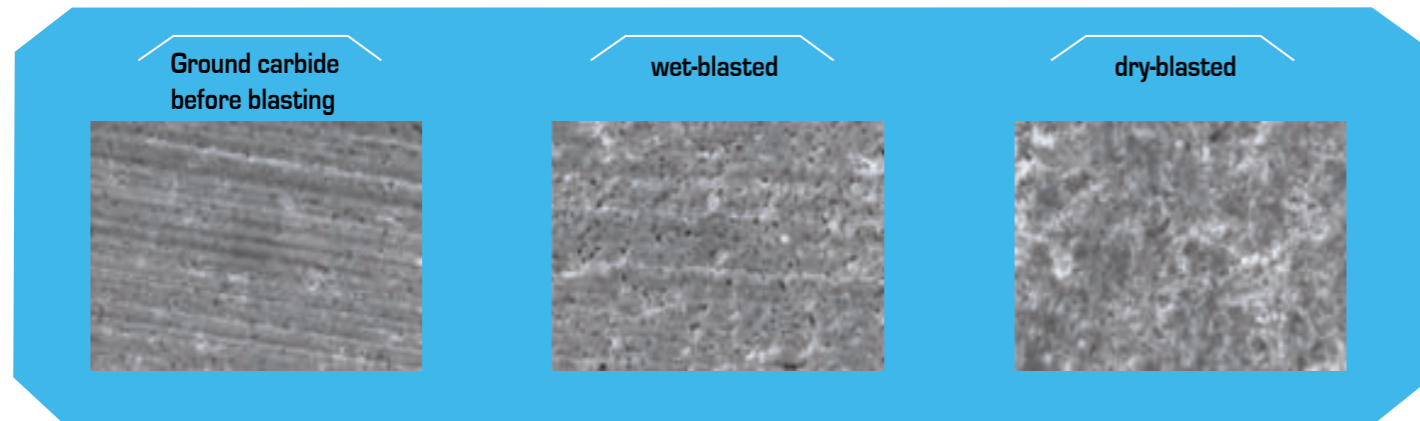

Comparison	Wet	Dry
Surface roughness	Sa = 0.05 µm; Sz = 0.32 µm Slightly shiny surface	Sa = 0.11 µm; Sz = 1.14 µm
Residual material after blasting	Risk of cobalt leaching due to the water	Smearing of the residual material
Coating adhesion	HF1	HF1 – HF3
Edge rounding	Good to control	Difficult to control
Grain size	Mesh 320 (50 µm), coarse, for edge rounding Mesh 400 (37 µm), medium, for surface activation Mesh 500 (30 µm), fine, for polishing	
Typical micro-blasting time [min] for hobs ø 80 mm; R = 10 µm	3	6
Advantages and disadvantages	Pre-cleaning not necessary Drying needed after blasting Difficult to clean after interruption Fewer abrasive inclusions in the tool surface Low surface roughness at the same edge rounding	Pre-cleaning necessary No need for drying after blasting Easy handling even after interruption More abrasive inclusions in the tool surface High surface roughness at the same edge rounding

Cutting-edge rounding and surface quality

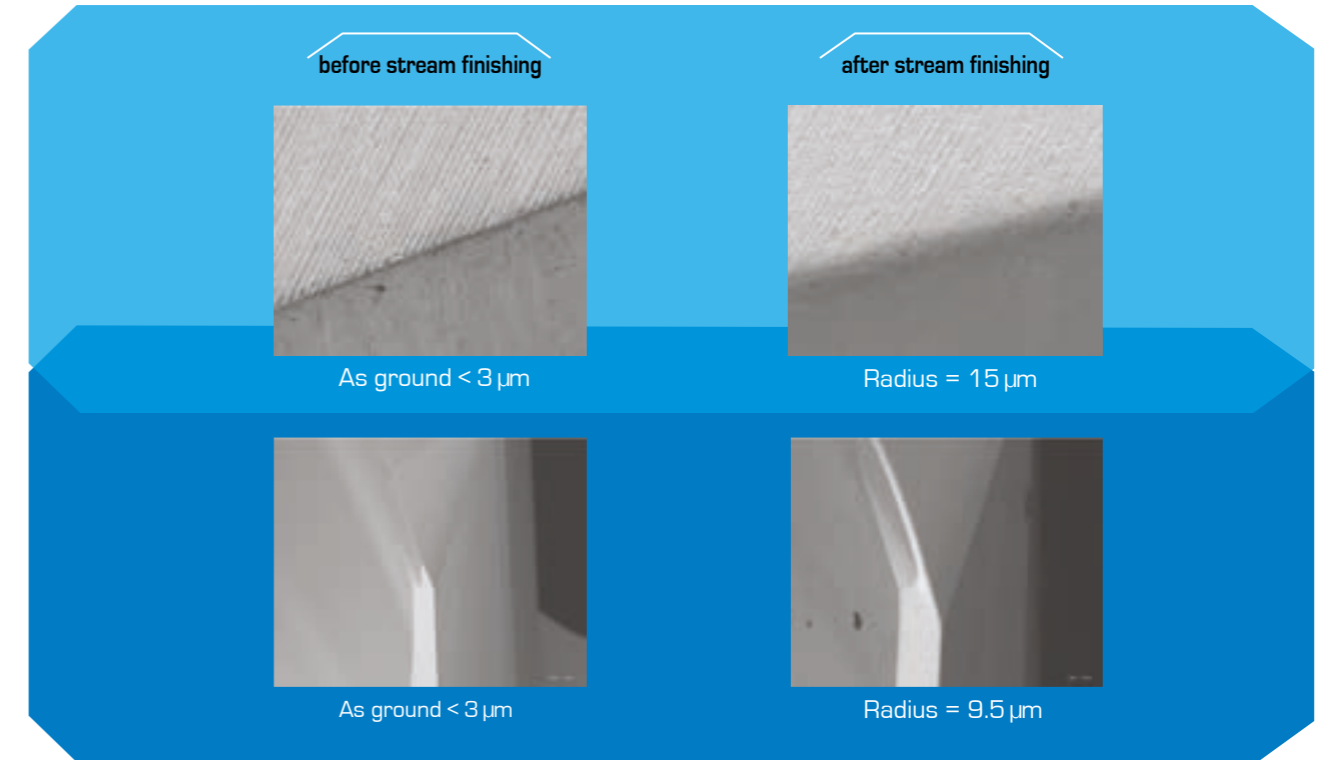

Depending on the required edge rounding, different media are applied.

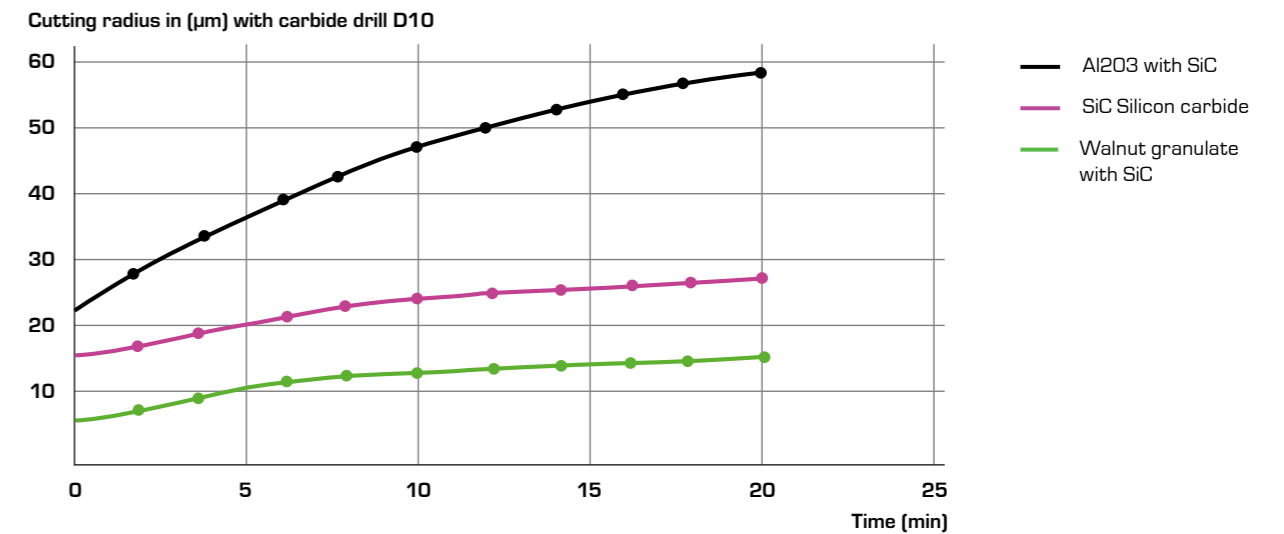

Cleaning

A clean metallic surface is necessary for coating. Contamination such as grinding residue, oil or dust weaken the coating's adhesion.

The industrial single-chamber cleaning units from PLATIT are the result of a partnership with Eurocold:

- Chamber sizes adapted to coating units by PLATIT
- Fully automatic cleaning process including vacuum drying
- Intuitive touch screen with real-time process parameters
- Remote diagnosis and maintenance
- Independent of environmental conditions as the system is closed

PLATIT offers two different standard sizes of single-chamber cleaning units, which can be tailored to individual customer needs on request, e.g. in terms of:

- Number of cleaning baths
- Bath filtration
- Immersion rinsing
- Tool sizes



Cleaning unit	V111	V411
Chamber volume [mm]	W 350 x D 390 x H 480	W 500 x D 500 x H 500
Loading for shank tools ø 10 x 70 [mm]	504 pcs.	1,008 pcs.
Max. load [kg]	150	200
Cycle times [min]	Approx. 45	Approx. 45

Cleaning cycle

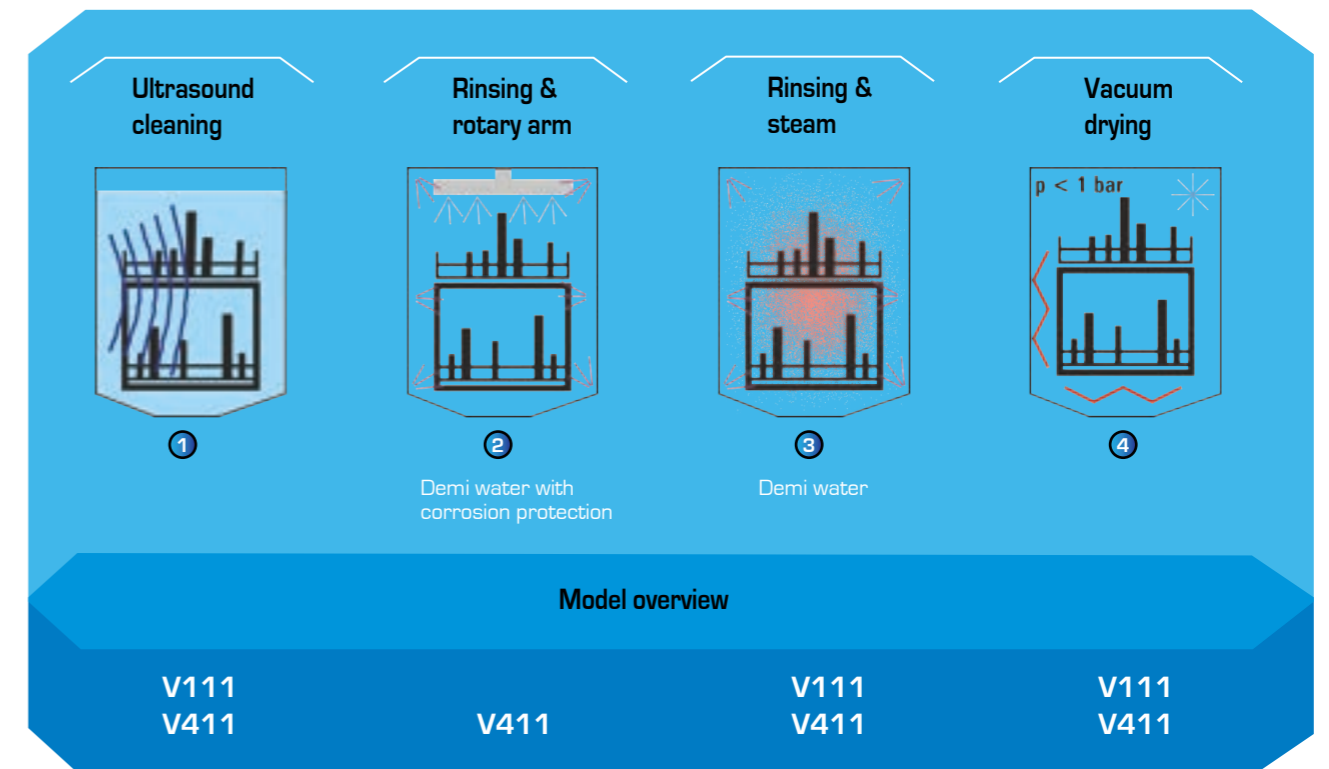

Advantages of a single-chamber cleaning unit compared to a cleaning line

	Single-chamber cleaning unit	Cleaning line
Footprint	Compact	Very big (long)
Sensitive to environment	No	Yes (lower with housing)
Evaporation	No	Yes
Ventilation necessary	No	Yes
Controlled atmosphere	Yes	Limited
Throughput (with the same bath size)	Low	High
Detergent selection	Limited	Full flexibility
Detergent carry-over	No	Yes
OSCILLation	No	Yes
Heavy tools	Easy handling	Depends on crane
Investment	Medium	High
Energy consumption	Medium	High

Quality control

Thickness and adhesion are important characteristics of a coating. They need to be controlled and monitored to guarantee a constant level of performance.



PQCS_PLATIT Quality Control Software

PQCS is a quality control software developed by PLATIT. The software is optimized for easy and fast data acquisition by recording batch photos, coating thickness and adhesion. All data is stored in a database to generate a coating report and provide a graphical representation of quality trends.

Advantages:

- Simple user interface
- Generating a coating report step by step to record the coating quality
- Automatic database entries including customer information, batch information and a photo, calo and Rockwell image, as well as adhesion report with scratch tester
- User-defined fields can be integrated
- The data can be filtered and represented graphically to recognize quality trends



Methods for quality control

The basic quality control methods of a PVD coating are:



- Coating thickness measurement using a calo tester on test plates and tools
- Adhesion evaluation using a Rockwell or scratch tester

Products and integration services available from PLATIT.



Calo test





Rockwell test

Scratch test

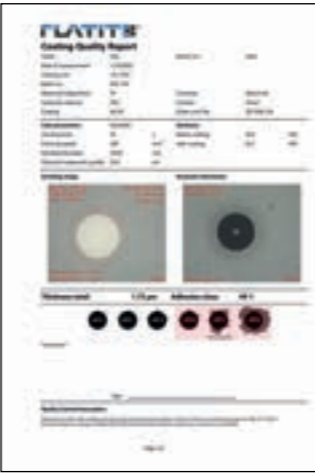

Coating report

Post-treatment

Objectives of post-treatment

- Removal of droplets after coating
- Reduction of surface roughness
- Improved chip flow for cutting tools

One of the problems that can arise without post-treatment of the surfaces is the jamming of the chips, which can cause a tool such as a drill to break.

Overview of the most common post-treatment methods

Method	Wet blasting	Stream finishing	Polishing
Tool type			
Drills	+++	++	+++
End mills	+++	+++	+++
Inserts	+++	+	+
Hobs	+++	+	-
Punches	+++	+++	+++
Molds and dies	+++	+	+++
Characteristics			
Stability	+++	+++	-
Flexibility	++	+	+++
Productivity	+++	++	+
Groove polishing possible	+	++	+++
Droplet removal possible	+	++	+++
Automation solutions possible	Yes	Yes	No
Special characteristics	Universally usable	Smooth surface	Very smooth surface

+++ High quality and high efficiency
 ++ High quality or high efficiency
 + Low quality and/or low efficiency
 - Not suitable for the system

If the post-treatment is too intense, the edge will become exposed. This will lead to:

- Immediate full and direct contact of the cutting-edge with the workpiece material
- Low thermal and chemical insulation
- Low coating thickness near the cutting-edge
- A larger cutting-edge radius, which results in a larger surface area without coating
- The impression of a defective coating



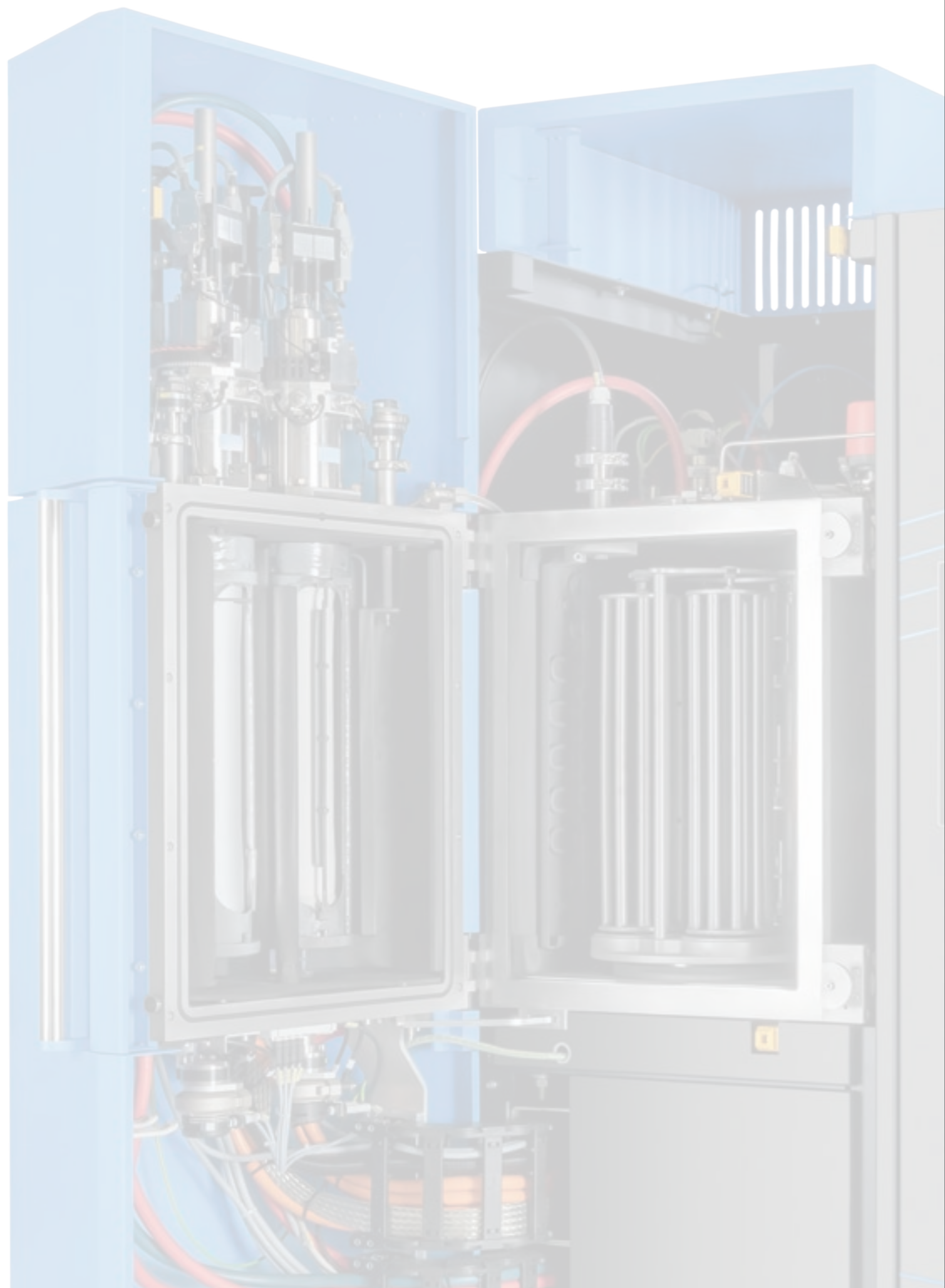

PLATIT'S LIFECYCLE MANAGEMENT



PLATIT® 11-Series

Service throughout the entire life cycle of your unit

At PLATIT, you enjoy service that leaves no questions unanswered. Whether you need spare parts or new cathodes, advice or upgrades: Our experts will make sure that your coating unit operates optimally at all times, ensuring that you achieve the best possible coating performance.



Spare parts for your PVD unit

Unwanted downtime of your unit must be avoided, as it costs your company money and customer loyalty. For this reason, we place the utmost importance on the smooth supply of important spare parts.

Our central warehouses in the Czech Republic, Switzerland, the United States and China guarantee fast delivery times and short distances for the supply of a wide range of spare parts. The service teams at these locations can be reached via the hotline and always provide top-level support.

As our customer, you get access to our online service database, in which your PVD unit is already entered. Here, in addition to your technical advisor, you will also find detailed information on spare parts for your coating unit, exploded drawings as well as the service history and condition of your machine in order to facilitate targeted problem solving.

Support solutions for rapid assistance with problems

Our mission is to support you in everything that concerns your PLATIT PVD coating unit. From the first questions asked shortly after installation to advice years later.

Training programs will help you and your staff take full advantage of the capabilities of your new PVD unit right from the start.

Our online service database is available 24/7 to provide quick and practical answers to frequently asked questions. In this way, many minor everyday hurdles can be quickly eliminated.



Through our hotline, our service technicians provide full support for more complex issues or difficult problems related to your unit. This extends to remote diagnostics, where our experts go through the process with you step by step to identify the source of the fault.

Of course, we will regularly be at your facility for maintenance if you engage us. At this time, many questions can be clarified, and processes improved if necessary.

Don't forget to ask about our service packages! These packages offer numerous advantages and ensure that your unit always receives the attention it needs.

The Premium Plus package

One example is our Premium Plus package, which aims to increase OEE (Overall Equipment Efficiency). Over the term of the contract, the package includes:

- 24 months warranty
- 2 service technician visits incl. spare parts: 12 and 24 months after commissioning
- Complete support via hotline and internet
- All working hours and travel expenses of the service technicians.

For the first two years, the Premium Plus package guarantees maximum uptime for your coating system, maximum planning reliability, cost transparency, reduced maintenance costs, and improved performance with consistent coating quality.



Upgrades and Retrofits for a long life of your unit

Like any high-tech unit, PLATIT's PVD units are continuously evolving and improving with each generation. With our upgrade programs, you can add new performance dimensions to existing coating units or bring the productivity of your system up to the latest state-of-the-art.

Retrofit measures allow you to technically rejuvenate unit components in a targeted manner and thus significantly extend the overall service life of the unit. Replacing components such as drives, pumps, sensors or controls can boost efficiency, making your PVD unit even more economical to run.



Cathode exchange – uncomplicated and fast

For our customers we have organized the cathode exchange very conveniently. To avoid storage costs, we take care of the transport of new cathodes and the environmentally friendly recycling of your used targets.

We guarantee the first-class workmanship of the targets and their material quality. Our specialists will be happy to explain to you how the cathodes can be replaced quickly and safely.

By the way: All rotating cathodes in PLATIT's Pi coating units have a lifetime warranty if the cathodes are changed regularly at one of PLATIT's cathode exchange centers.

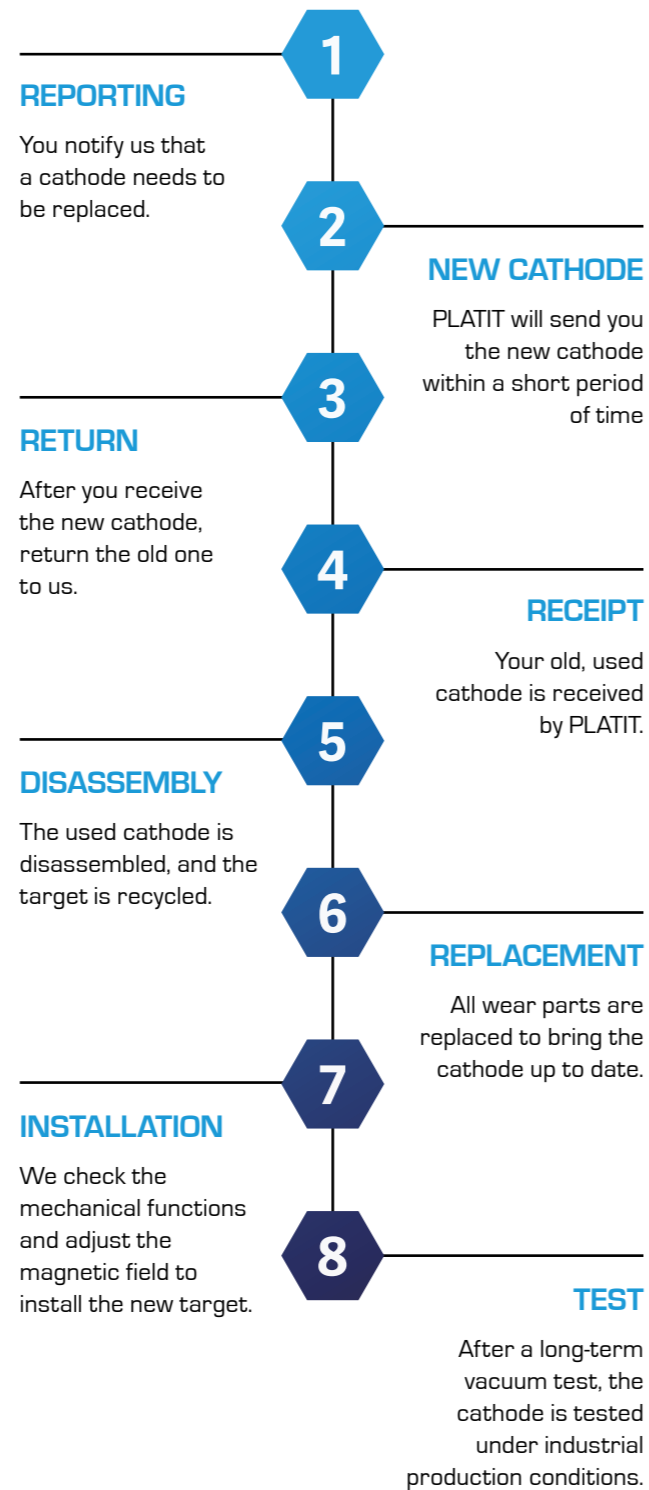
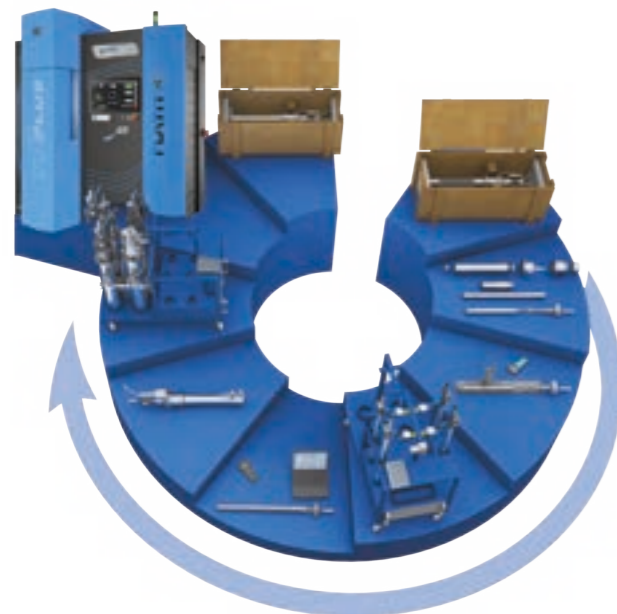

Cathode exchange centers – close to you

With service organizations in Europe, North America and Asia, we operate 4 Cathode Exchange Centers (CEC) worldwide.

One of them is also near you.

PLATIT SHANGHAI	PLATIT Inc.	KOREA	PLATIT A.S.
Service & CEC Asian region	Service & CEC North and South America	CEC South Korea	Service & CEC All other regions
No. 161 Rijing Road (Shanghai) PFTZ CN-200131 Pudong Shanghai	1312 Armour Blvd., Mundelein IL 60060 USA	SQ Tech Co., Ltd. 283 Bupyeong-daero Bupyeong-Gu, Incheon KR-21315	Průmyslová 3020/3 CZ-78701 Šumperk IN (IČ): 25904795 TAX IN (DIČ): CZ25904795
service-cn@platit.com +86 215 833 8069	service-us@platit.com +1 855 475 2848	korea@platit.com +82 32 623 7800-6	service-eu@platit.com +420 733 743 733



Sales partners & agents

Austria

Alfleth Engineering AG
AT-4580 Windischgarsten
info@platit.com
+43 676 847 004 100

Brazil

Rastertools M. e F. Ltda
BR-13480-051 Limeira SP
brazil@platit.com
+55 19 99748 3167

Bulgaria

Alfleth Engineering EOOD
BG-4006 Plovdiv
info@platit.com
+359 32 620 685

Germany

AR Industrievertretungen
DE-70567 Stuttgart
germany@platit.com
+49 711 7187 6340

Hungary

Alfleth Magyarország Kft.
HU-1117 Budapest
info@platit.com
+36 1 209 52 47

India

Industrial Interface India 3i
IND-400101 Mumbai
india@platit.com
+91 9833 6773 08

India

D & M Tech
IND-411026 Pune
india@platit.com
+ 91 8308 1066 77

Israel

TekTeam Ltd.
IL-6023201 Or-Yehuda
israel@platit.com
+97 236 323 576

Italy

S.I.M.U. S.r.l.
IT-10137 Torino
italy@platit.com
+39 011 3000 333

Kazakhstan, Kyrgyzstan, Uzbekistan

MEDEU Engineering LLP
KZ-160005 Shymkent City
info@platit.com
+7 747 395 10 71

Korea

SQ Commerce Co., Ltd
KR-21315 Incheon
korea@platit.com
+82 32 623 7800-6

Mexico

Presotec S.A.
MX-66600 Cd. Apodaca, N.L.
mexico@platit.com
+52 81 8375 4220

Poland

Technolutions
PL-99-400 Łowicz
poland@platit.com
+48 606 440 718

Portugal

Alida Castro LDA
PT-2635-654 Rio de Mouro
portugal@platit.com
+351 217 785 157

Romania

Alfleth Engineering AG
RO-500010 Brasov
info@platit.com
+40 268 510 012

Slovenia

Alfleth Engineering d.o.o.
SI-1217 Vodice
info@platit.com
+386 1 833 20 83

Spain

Technalloy S.A.
ES-08174 Barcelona
spain@platit.com
+34 609 539 570

Turkey

Erde Dis Ticaret Ltd. Ş. ti.
TR-34722 Hasanpasa, Kadıköy, Istanbul
turkey@platit.com
+ 90 216 330 2400



VISIT US AT: WWW.PLATIT.COM

PLATIT AG

Headquarters
Eichholzstrasse 9
CH-2545 Selzach
info@platit.com
+41 32 544 62 00

PLATIT (Shanghai) Co., Ltd.

Sales, R&D, Service, CEC
No. 161 Rijjing Road (Shanghai) PFTZ
CN-200131 Pudong Shanghai
china@platit.com
+86 2158 6739 76

PLATIT a.s.

Production, R&D, Service, CEC
Průmyslová 3020/3
CZ-78701 Šumperk
info@platit.com
+420 583 241 588

PLATIT Inc.

Sales, Service, CEC
1312 Armour Blvd.,
Mundelein IL 60060, US
usa@platit.com
+1 847 680 5270

COMPENDIUM



PLATIT®
Advanced Coating Systems
SWISS  QUALITY